

ALIAS 
DESIGN SECURITY DOORS

Guardare
al futuro
anticipando
i tempi

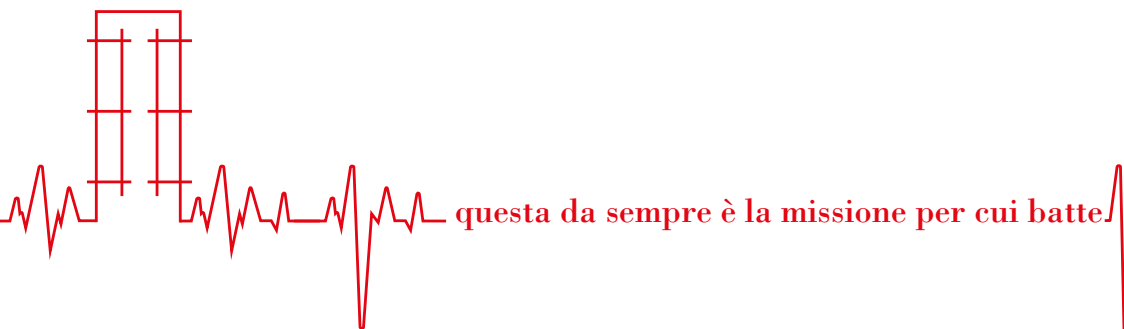



questa da sempre è la missione per cui batte il cuore Alias.



ALIAS 
DESIGN SECURITY DOORS

CERTIFICAZIONI

Certifications

LE GRATE
ANTIEFFRAZIONE
ALIAS SONO
CERTIFICATE PER LA
RESISTENZA
ALL'EFFRAZIONE
PRESSO IL CSI,
ISTITUTO DI TESTING
E CERTIFICAZIONE
RICONOSCIUTO A
LIVELLO EUROPEO.

		DIVISIONE: TESTING-CERTIFICAZIONE DIVISION: TESTING & CERTIFICATION		LABORATORIO: Idraulica LABORATORY: Hydraulics	
RAPPORTO DI PROVA <i>(Test Report)</i>		Pag. 1/20 di 20 pag.		N° 0025/DCAEF16 Rev. 1	
IDENTIFICAZIONE E DESCRIZIONE DEL CAMPIONE: SPECIMEN DESCRIPTION:		Serie DEFENDER			
DATI IDENTIFICATIVI DEL CLIENTE: CLIENT:		ALIAS SRL Via Berlinguer, 22 29020 Settima di Gossolengo (PC)			
NORMA DI RIFERIMENTO: REFERENCE STANDARD:		UNI EN 1627:2011			
DISTRIBUZIONE ESTERNA: OUTSIDE DISTRIBUTION:		ALIAS SRL			
UNITÀ DI ACCREDITAMENTO: ACCREDITATION BODY:					



		RAPPORTO DI PROVA <i>(Test Report)</i>		Pag. 14/20 di 20 pag.	
N° 0025/DCAEF16 Rev. 1		Data: 27/05/2016			
D) CLASSIFICAZIONE / CLASSIFICATION					
L'insieme dei dati acquisiti nel corso delle prove riportate nel presente rapporto di prova, soddisfa i requisiti di classe 3 (THREE) di resistenza all'effrazione secondo la norma UNI EN 1627:2011. <i>The whole test values, reported in this test report, meet the requirements for burglar resistance class 3 (THREE) according to EN 1627:2011.</i>					
DATA Date:		Settore Fisica delle Costruzioni Building Physics Sector		Area Testing Testing Area	
27/05/2016		G. De Napoli		Paolo Famagalli	
Documento firmato digitalmente ai sensi del D. Lgs. N. 82 del 7 Marzo 2005 e successive modifiche <i>Digitally signed document in accordance with Legislative Decree n. 82 dated March 7th 2005 and subsequent amendments.</i>					
ALLEGATI / ANNEVES					
Allegato / Annex 1: Schema punti di carico / Loading points sketch Allegato / Annex 2: Schema punti d'impatto / Impact points sketch Allegato / Annex 3: Disegno tecnico / Technical drawing					
					





INDICE / INDEX

LINEA DEFENDER CLASSE 3 LIGNE DEFENDER CLASS 3	PAG. 13
LINEA DEFENDER 3 ANTE LIGNE DEFENDER A TROIS VANTAUX	PAG. 63
LINEA FIGHTER CLASSE 2 LIGNE FIGHTER CLASS 2	PAG. 69
GRATE CON SUPPLEMENTO FISSI SUPERIORI GRILLES AVEC ELEMENTS FIXES SUPÉRIEURS	PAG. 80
KIT GRATE KIT GRILLES	PAG. 82
COLORI E FINITURE DISPONIBILI COULEURS ET FINITIONS DISPONIBLES	PAG. 86

Les grilles de sécurité
Alias sont certifiées
pour la résistance à
l'effraction par le CSI,
Institut d'essai et
certification reconnu
au niveau européen.

		DIVISIONE: TESTING-CERTIFICAZIONE DIVISION: TESTING & CERTIFICATION		LABORATORIO: FISICA DELLE COSTRUZIONI LABORATORY: CONSTRUCTION PHYSICS	
RAPPORTO DI PROVA <i>(Test Report)</i>		Pag. 1/23 di 23 pag.		N° 0033/DCAEF17	
IDENTIFICAZIONE E DESCRIZIONE DEL CAMPIONE: SPECIMEN DESCRIPTION:		Grata singola anta mod. FIGHTER Single leafdoor grating mod. FIGHTER			
DATI IDENTIFICATIVI DEL CLIENTE: CLIENT:		ALIAS SRL Via Berlinguer, 22 29020 Settima di Gossolengo (PC)			
NORMA DI RIFERIMENTO: REFERENCE STANDARD:		UNI EN 1627:2011			
DISTRIBUZIONE ESTERNA: OUTSIDE DISTRIBUTION:		ALIAS SRL			
UNITÀ DI ACCREDITAMENTO: ACCREDITATION BODY:					

		RAPPORTO DI PROVA <i>(Test Report)</i>		Pag. 22/23 di 23 pag.	
N° 0033/DCAEF17		Data: 03/08/2017			
D) CLASSIFICAZIONE / CLASSIFICATION					
L'insieme dei dati acquisiti nel corso delle prove riportate nel presente rapporto di prova, soddisfa i requisiti di classe 2 (TWO) di resistenza all'effrazione secondo la norma UNI EN 1627:2011. <i>The whole test values, reported in this test report, meet the requirements for burglar resistance class 2 (TWO) according to EN 1627:2011.</i>					
DATA Date:		Settore Fisica delle Costruzioni Building Physics Sector		Area Testing Testing Area	
03/08/2017		G. De Napoli		Ing. P. Famagalli	
Documento firmato digitalmente ai sensi del D. Lgs. N. 82 del 7 Marzo 2005 e successive modifiche <i>Digitally signed document in accordance with Legislative Decree n. 82 dated March 7th 2005 and subsequent amendments.</i>					
ALLEGATI / ANNEVES					
Allegato / Annex 1: Schema punti di carico / Loading points sketch Allegato / Annex 2: Schema punti d'impatto / Impact points sketch					
					



LA FORTE IDENTITÀ DI ALIAS, LEADER DI SETTORE SUL TEMA DELLA SICUREZZA DELLE PORTE D'INGRESSO, HA PORTATO L'AZIENDA A ESTENDERE NATURALMENTE LA SUA GRANDE CAPACITÀ DI VISIONE ANCHE ALLA SICUREZZA DI TUTTE LE ALTRE APERTURE ESTERNE DELLA CASA. COME PER LE PORTE D'INGRESSO, ANCHE PER LE GRATE DI SICUREZZA ALIAS SEGUE DA VICINO TUTTE LE FASI DELLA PRODUZIONE: DALLA PROGETTAZIONE - GRAZIE AL DIPARTIMENTO DI RICERCA&SVILUPPO INTERNO ALL'AZIENDA - ALLA LAVORAZIONE DELL'ACCIAIO, ALL'ASSEMBLAGGIO E ALLA VERNICIATURA. QUESTO PER GARANTIRE AL PROCESSO INDUSTRIALE DELLA PRODUZIONE LA MASSIMA QUALITÀ DEL PRODOTTO FINITO, SIA DAL PUNTO DI VISTA TECNICO-COSTRUTTIVO CHE ESTETICO.

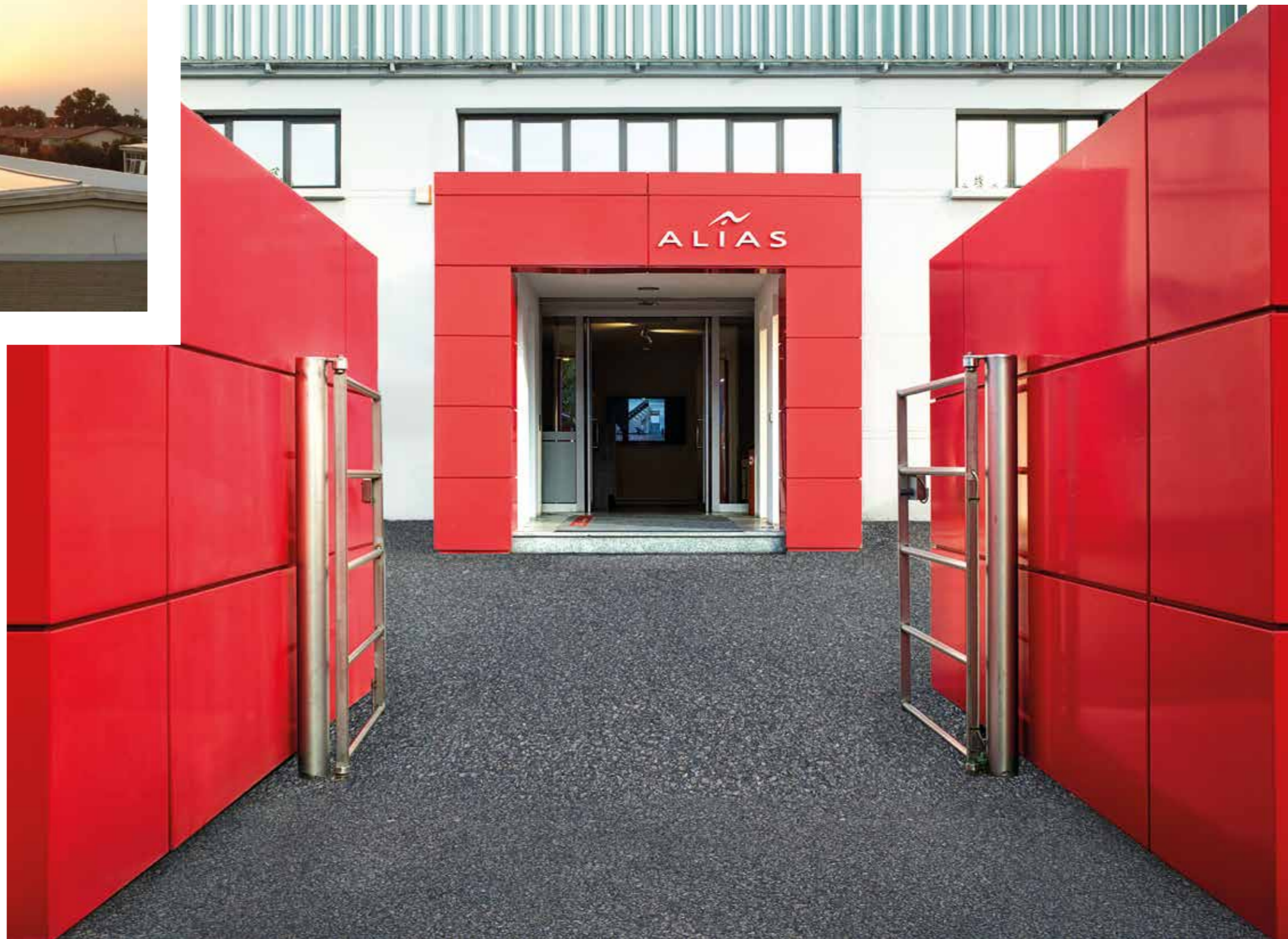

La forte identità de l'entreprise, leader en matière de sécurité des Portes d'entrée, a conduit l'entreprise à étendre naturellement sa grande capacité de vision à la sécurité de toutes les autres ouvertures extérieures de la maison. Alias suit toutes les phases de production aussi pour les grilles de sécurité: a partir de l'idée- grâce au département de recherche et développement interne - au travail, montage et peinture de l'acier. Ceci pour assurer la plus haute qualité du produit fini tant de point de vue technique qu'esthétique.



LA TECNOLOGIA DEL TAGLIO LASER AL SERVIZIO DI UN PRODOTTO IN TOTALE STILE ALIAS, PRECISO ED ESSENZIALE.

IL ROBOT LASER TUBO PERMETTE DI EFFETTUARE LAVORAZIONI DI ALTA PRECISIONE CREANDO INCASTRI CHE CONSENTONO DI ABBANDONARE ANTIESTETICHE SALDATURE A VISTA.

INOLTRE LA VELOCITÀ DI LAVORAZIONE SODDISFA IN PIENO L'ESIGENZA DI UNA PRODUZIONE SEMPRE AL PASSO CON I TEMPI IN UN MERCATO SEMPRE PIÙ ESIGENTE.

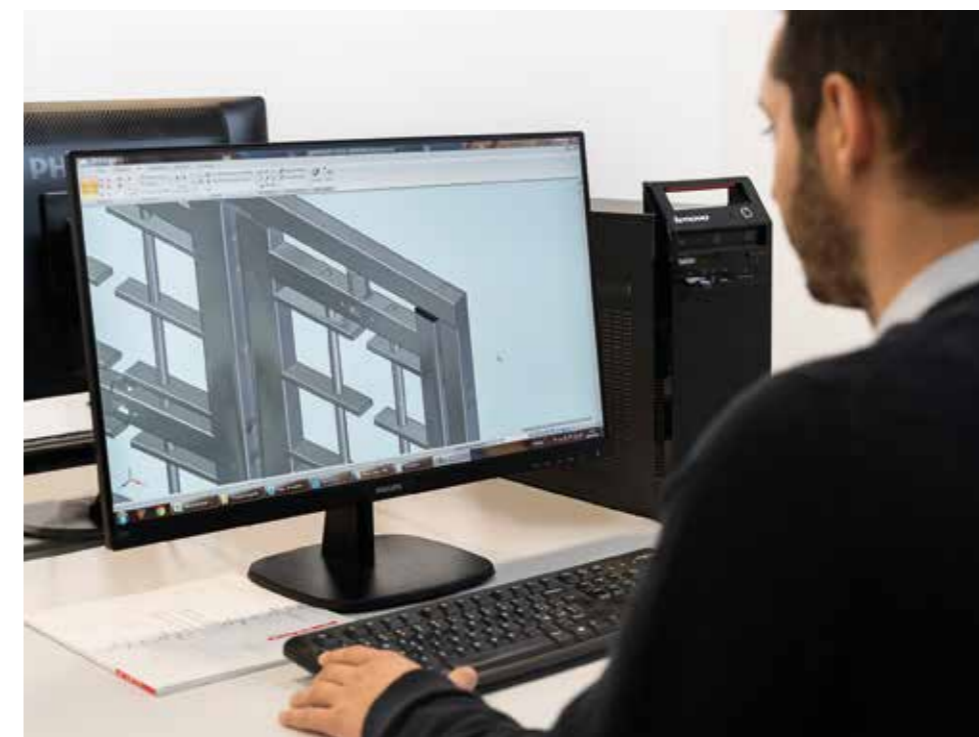

La tecnologia de coupe laser au service d'un produit selon le style total alias, précis et essentiel.

Le tube laser robot permet de réaliser un traitement de haute précision en créant des joints qui permettent de renoncer aux antiesthétiques soudages.

De plus, la rapidité d'usinage satisfait pleinement le besoin d'une Production toujours en phase avec son temps dans un marché de plus en plus exigeant.



PER UN OTTIMO PRODOTTO SONO NECESSARIE LE MIGLIORI MATERIE PRIME E ALIAS DA SEMPRE SI PONE IN QUESTA PRECISA DIREZIONE. I TUBI E LE BARRE PIENE LAVORATE DAL LASER SONO DI PRIMA SCELTA IN ACCIAIO ZINCATO DX51D + Z200/ Z275, PER GARANTIRE LA MASSIMA RESISTENZA NEL TEMPO.

Pour un excellent produit, on a besoin des meilleures matières premières et alias se pose toujours dans cette direction. Les tubes et les barres solides usinées au laser sont acier galvanisé de premier choix en dx51d + z200 / z275, pour garantir résistance dans le temps. Grâce à une usine de peinture en poudre semi-automatique, alias est capable d'emballer un produit de haute qualité. Ce système de coloration est l'un des plus résistants et protège parfaitement la grille contre les intempéries. En plus d'une large gamme de couleurs standard, il est possible de demander des finitions personnalisées.



GRAZIE AD UN IMPIANTO SEMI AUTOMATICO DI VERNICIATURA A POLVERE ALIAS È IN GRADO CONFEZIONARE UN PRODOTTO DALLE ALTE FINITURE. QUESTO SISTEMA DI COLORAZIONE È FRA I PIÙ RESISTENTI E PROTEGGE PERFETTAMENTE LA GRATA DAGLI AGENTI ATMOSFERICI. OLTRE AD UN'AMPIA GAMMA DI COLORI STANDARD È POSSIBILE RICHIEDERE FINITURE PERSONALIZZATE.





CON LE GRATE ANTIEFFRAZIONE, NATURALE COMPLETAMENTO DELLA SICUREZZA FIRMATA ALIAS, PROTEGGI L'INTERO PERIMETRO DELLA TUA CASA.

SICUREZZA, INNOVAZIONE, PERFORMANCE, DESIGN NON SOLO PER LA PORTA D'INGRESSO, MA ANCHE PER TUTTI GLI ALTRI VARCHI, COME FINESTRE E PORTEFINESTRE.

ALIAS, CHE FIN DAI SUOI ESORDI HA FATTO DELLA CONTINUA RICERCA LA PROPRIA MISSIONE, CONIUGANDO LE ABILITÀ DELLE MAESTRANZE ARTIGIANALI CON I PROCESSI INDUSTRIALI, E' OGGI GARANZIA D'INVIOLABILITÀ DELLA CASA A 360°.

Avec des grilles de sécurité achèvement naturel de la sécurité signée alias, protégez tout le périmètre de votre maison.

Sécurité, innovation, performance, design non seulement pour la porte d'entrée, mais aussi pour tout le reste comme fenêtres et portes fenêtres. Alias, qui depuis ses débuts a fait de la recherche propre mission, en combinant les compétences de l'artisanat avec les processus industriel, c'est aujourd'hui garantie de sécurité de la maison à 360°.

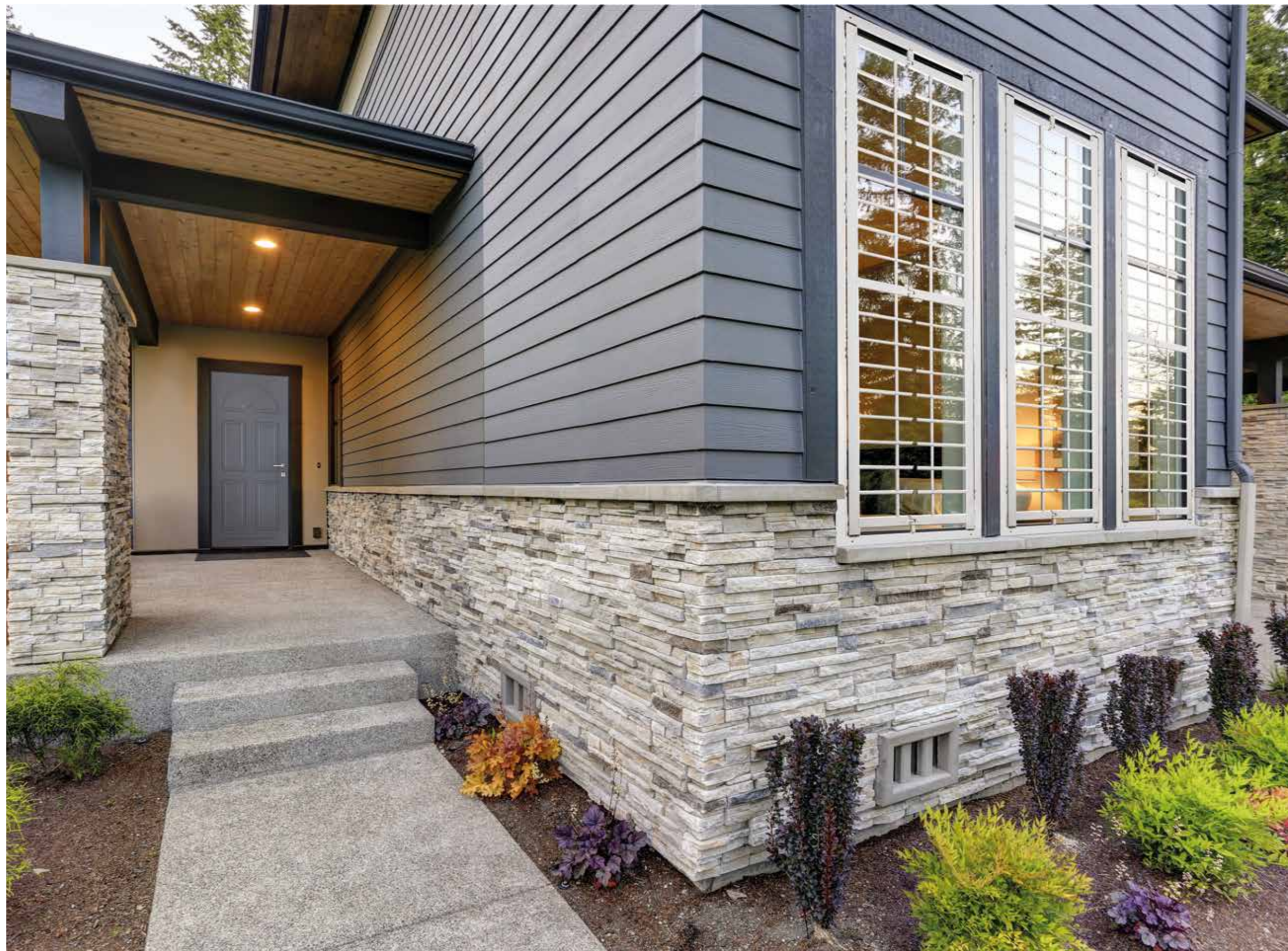

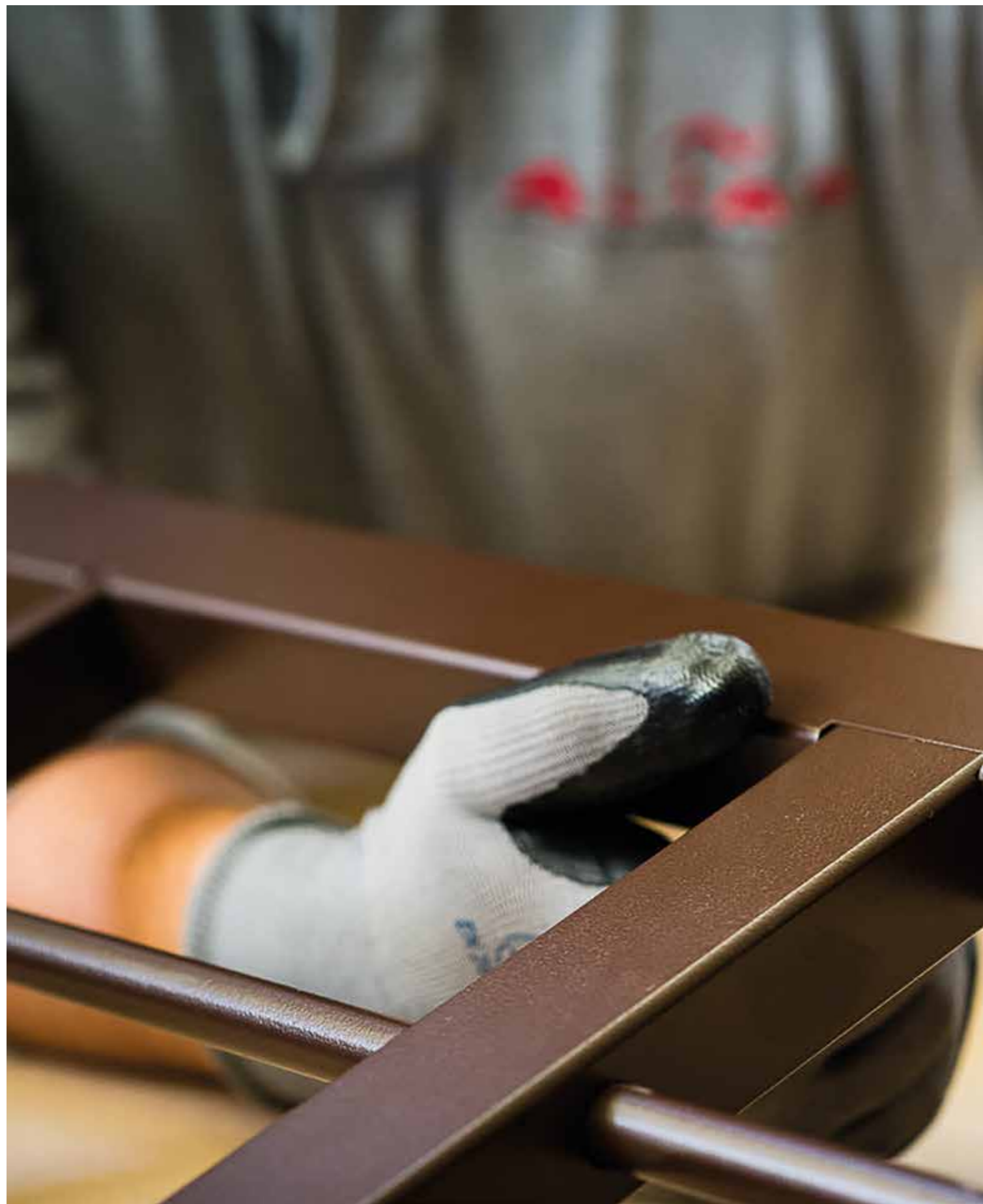

LINEA
DEFENDER
CLASSE 3

CERNIERE A SCOMPARSA DI SERIE E DUPLICE POSSIBILITÀ DI APERTURA: PARZIALE ALL'INTERNO DELL'AMBIENTE, TOTALE ALL'ESTERNO COMPLETAMENTE A RIDOSSO DEL SERRAMENTO E DELLA PERSIANA GRAZIE AD UN PRATICO SNODO DI DUE LUNGHEZZE DIFFERENTI.



Charnières invisibles standard et deux options d'ouverture: partielle à l'intérieur de la maison, totale à l'extérieur complètement près de la fenêtre et du volet grâce à une articulation de deux longueurs différentes

DEFENDER D100

D100 È L'ENTRY LEVEL DELLA LINEA DEFENDER.
SEMPLICE E MINIMAL DAL PUNTO DI VISTA ESTETICO, PUÒ ESSERE DOTATA DI BARRE
TONDE O QUADRATE. D100 È PER CHI AMA L'ESSENZIALITÀ.

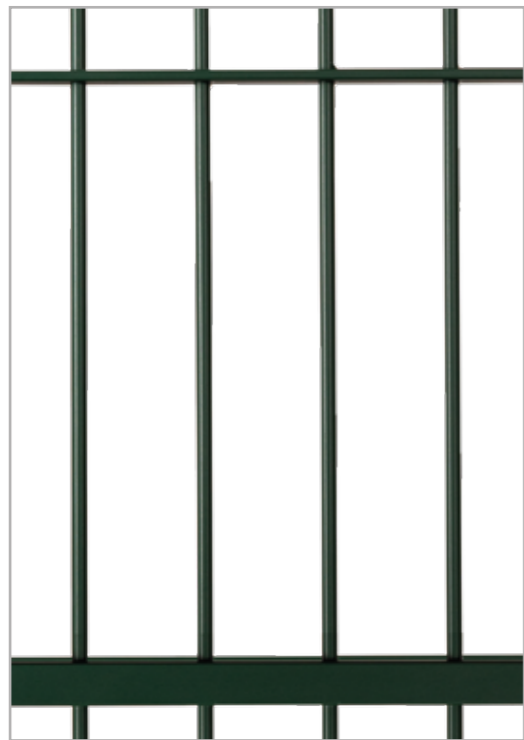

D100 est le niveau d'entrée de la ligne Defender. Simple et essentiel d'un point de vue esthétique, il peut être équipé de barres rondes ou carrées.
D100 est pour ceux qui aiment l'essentialité.



NELLA FOTO: DEFENDER D100 - BARRA PIENA TONDA, VERDE RAL 6005 GRINZ/
DANS LA PHOTO: DEFENDER D100 - BARRE RONDE COMPLÈTE - COULEUR VERT RAL 6005 GRINZ

**BARRA PIENA Ø14 MM
ALTERNATA A TUBO CON INSERTO
TONDINO CARBOCEMENTATO
ANTITAGLIO**

BARRE COMPLÈTE 14MM ALTERNÉE AVEC TUBE AVEC INSERT
ROND CARBOCÉMENTÉ' ANTI-COUPURE

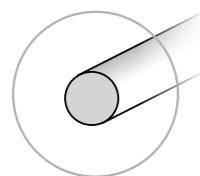

**BARRA PIENA
14X14 mm
NELLA VERSIONE
QUADRATA**

BARRE COMPLÈTE 14X14 MM
EN VERSION CARRÉE

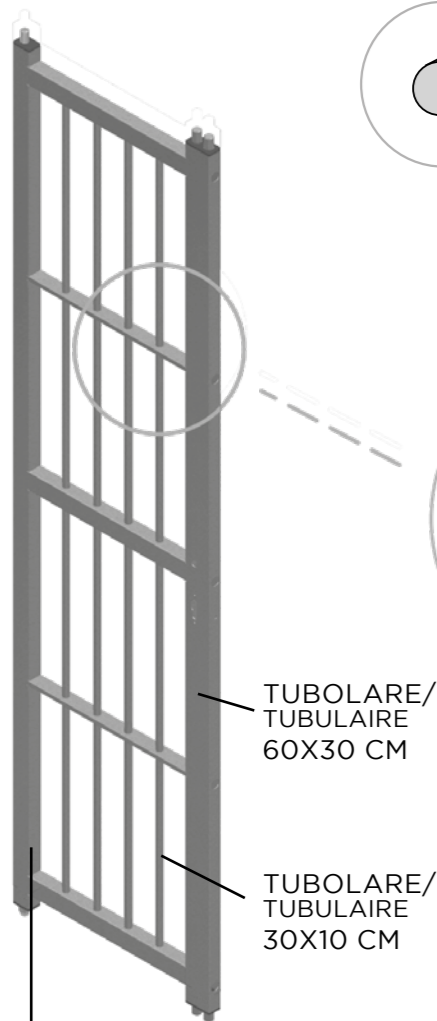
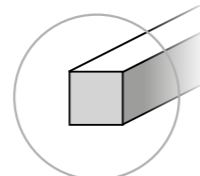

TUBOLARE/
TUBULAIRE
60X30 CM

TUBOLARE/
TUBULAIRE
30X10 CM

TUBOLARE/
TUBULAIRE
40X30 CM

**DEFENDER
D100**



**PORTA FINESTRA
2 Ante 2 Snodi**

PORTE FENÊTRE À 2 VANTAUX
2 ARTICULATIONS

**FINESTRA
2 Ante 2 Snodi**

FENÊTRE À 2 VANTAUX
2 ARTICULATIONS

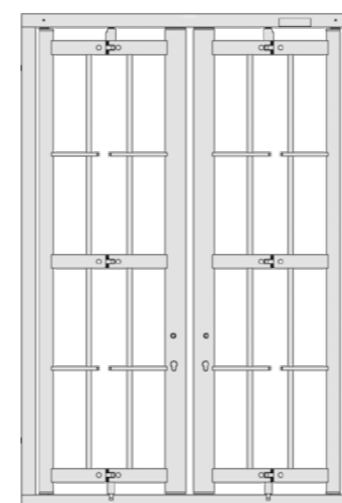

**FISSA
FIXE**

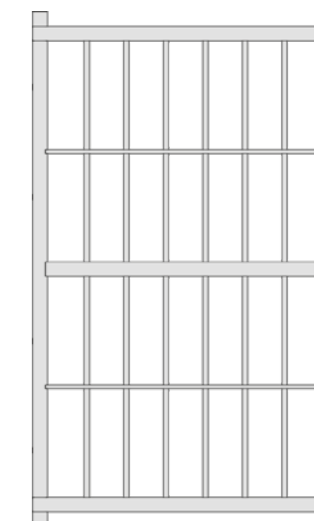

1 ANTA 2 SNODI
1 VANTAIL 2 ARTICULATIONS

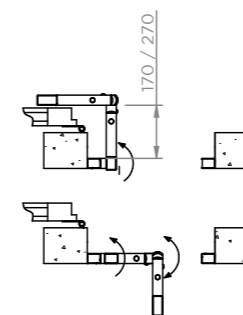

1 ANTA 1 SNODO
1 VANTAIL 1 ARTICULATION

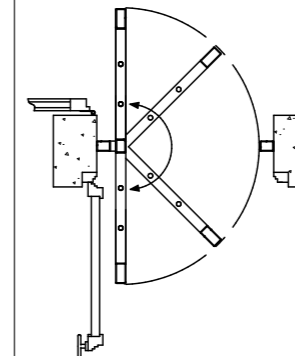

ANTA FISSA
VANTAIL FIX

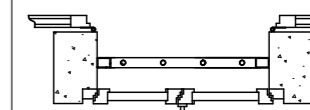

2 ANTE 2 SNODI
2 VANTAIL 2 ARTICULATIONS

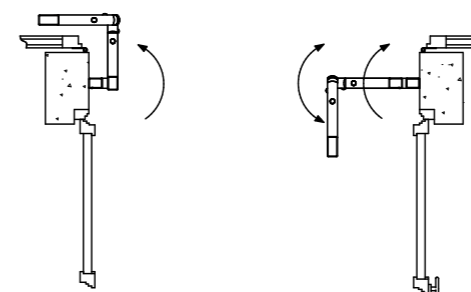

2 ANTE 1 SNODO
2 VANTAIL 1 ARTICULATIONS

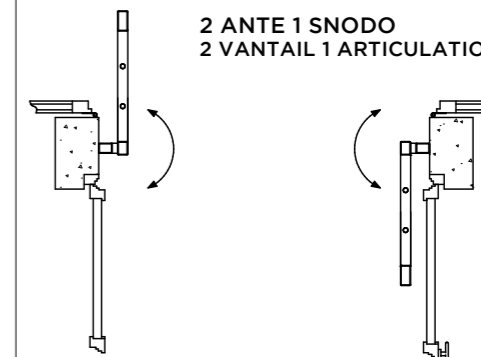

SOLUZIONI TECNICHE

SOLUTIONS TECHNIQUES

DEFENDER D200

D200, A DIFFERENZA DELLA VERSIONE BASE D100, INSERISCE IL CONCETTO DI DECORI -RIGOROSAMENTE FISSATI CON GRANO (NELLA VERSIONE CON BARRA TONDA) E SALDATI (NELLA VERSIONE CON BARRA QUADRATA). D200 È PER CHI AMA UNO STILE PIÙ CLASSICO



D200, contrairement à la version de base D100, introduit le concept des décorations - strictement fixées avec du fil (dans la version avec barre ronde) et soudées (dans la version avec barre carrée). D200 est pour ceux qui aiment un style plus classique.



NELLA FOTO: DEFENDER D200 - BARRA PIENA TONDA, MARRONE TDM GRINZ
DANS LA PHOTO: DEFENDER D200 - BARRE RONDE COMPLÈTE - COULEUR MARRON TDM GRINZ

**BARRA PIENA Ø14 MM
ALTERNATA A TUBO CON INSERTO
TONDINO CARBOCEMENTATO
ANTITAGLIO**

BARRE COMPLÈTE 14MM ALTERNÉE AVEC TUBE AVEC INSERT
ROND CARBOCÉMENTÉ' ANTI-COUPURE

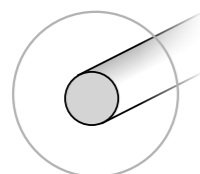

**BARRA PIENA
14X14 mm
NELLA VERSIONE
QUADRATA**

BARRE COMPLÈTE 14X14 MM
EN VERSION CARRÉE

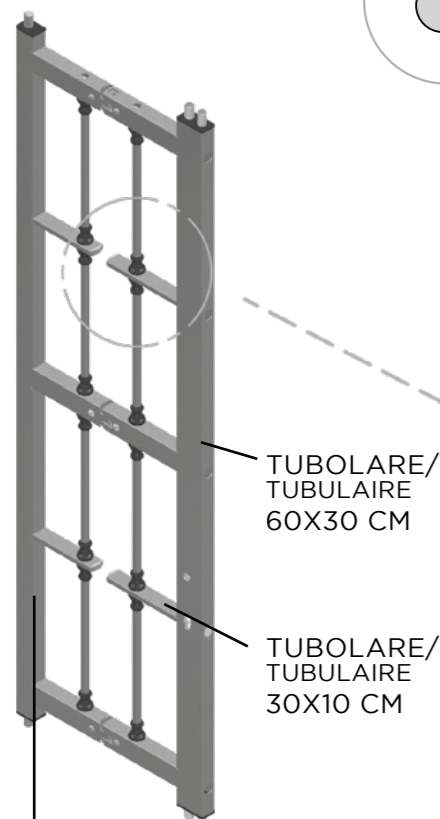
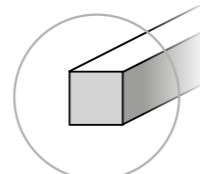

TUBOLARE/
TUBULAIRE
60X30 CM

TUBOLARE/
TUBULAIRE
30X10 CM

TUBOLARE/
TUBULAIRE
40X30 CM

**DEFENDER
D200**



**FINESTRA
2 Ante 2 Snodi**

FENÊTRE À 2 VANTAUX
2 ARTICULATIONS

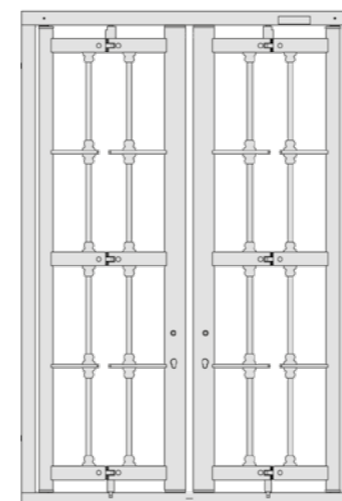

**PORTA FINESTRA
2 Ante 2 Snodi**

PORTE FENÊTRE À 2 VANTAUX
2 ARTICULATIONS

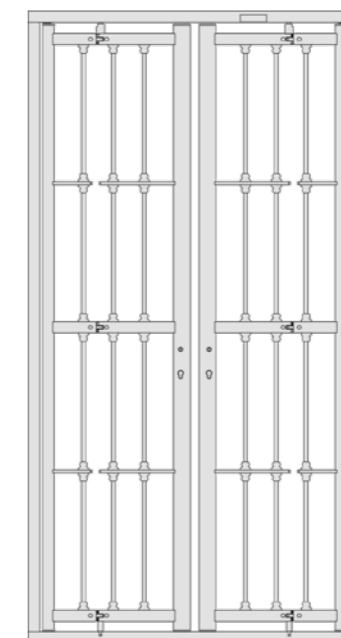

**FISSA
FIXE**

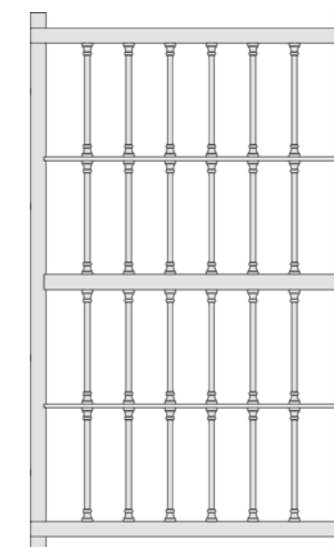

1 ANTA 2 SNODI
1 VANTAIL 2 ARTICULATIONS

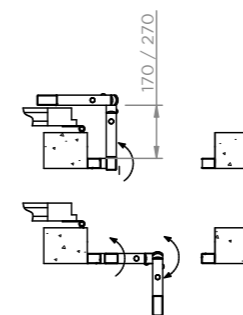

1 ANTA 1 SNODO
1 VANTAIL 1 ARTICULATION

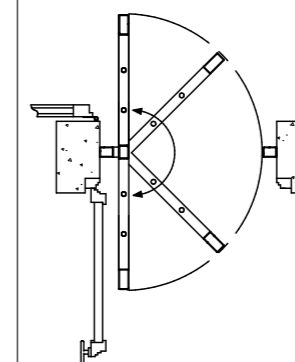

ANTA FISSA
VANTAIL FIX

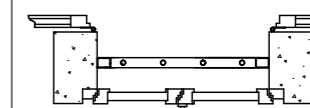

2 ANTE 2 SNODI
2 VANTAIL 2 ARTICULATIONS

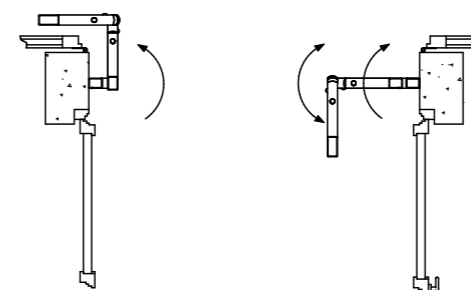

2 ANTE 1 SNODO
2 VANTAIL 1 ARTICULATIONS

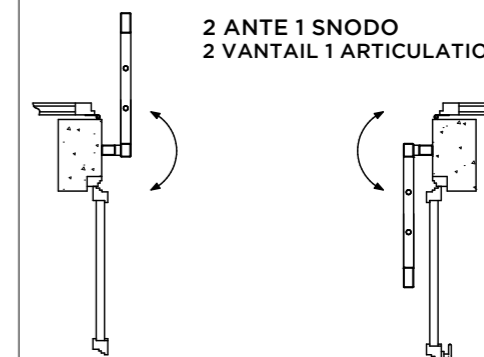

SOLUZIONI TECNICHE

SOLUTIONS TECHNIQUES

DEFENDER D300

CON D300, DISALLINEANDO LE BARRE ORIZZONTALI, SI OTTIENE UN OTTIMO COMPROMESSO FRA STILE CLASSICO E CONTEMPORANEO.
COMPROMESSO ANCOR PIÙ APPREZZABILE NELLA VERSIONE A DOPPIO SNODO.

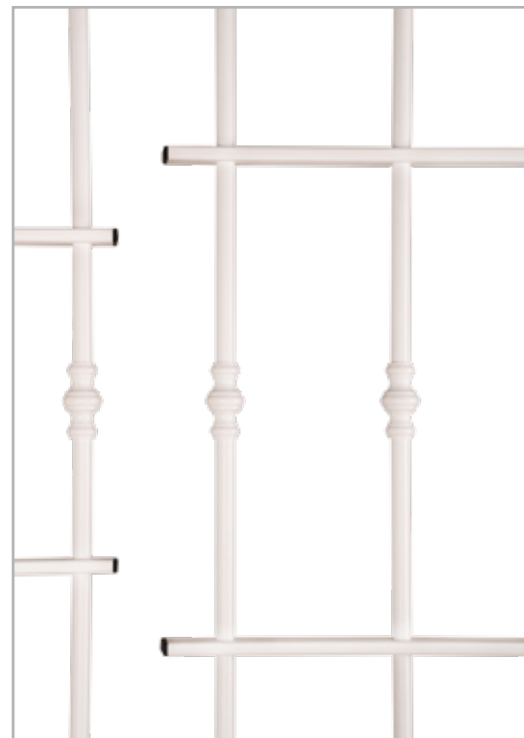

Avec le D300, en déplaçant les barres horizontales, on obtient un excellent compromis entre style classique et contemporain. Compromis encore plus appréciable dans la version à double articulation.



NELLA FOTO: DEFENDER D300 - BARRA PIENA TONDA, BIANCO GLITTER
DANS LA PHOTO: DEFENDER D300 - BARRE RONDE COMPLÈTE - COULEUR BLANC GLITTER

**BARRA PIENA Ø14 MM
ALTERNATA A TUBO CON INSERTO
TONDINO CARBOCEMENTATO
ANTITAGLIO**

BARRE COMPLÈTE 14MM ALTERNÉE AVEC TUBE AVEC INSERT
ROND CARBOCÉMENTÉ' ANTI-COUPURE

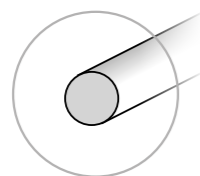

**BARRA PIENA
14X14 mm
NELLA VERSIONE
QUADRATA**

BARRE COMPLÈTE 14X14 MM
EN VERSION CARRÉE

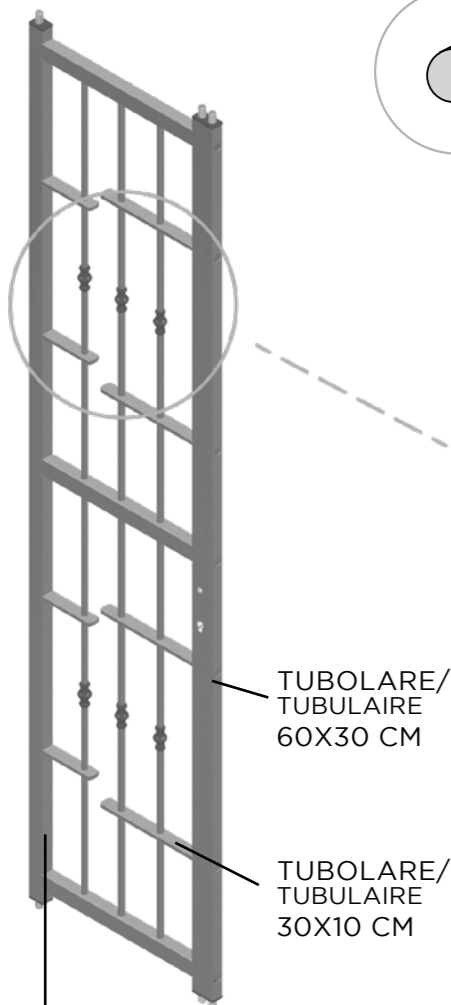
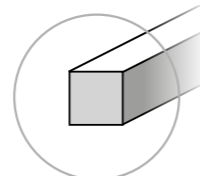

TUBOLARE/
TUBULAIRE
60X30 CM

TUBOLARE/
TUBULAIRE
30X10 CM

TUBOLARE/
TUBULAIRE
40X30 CM

**DEFENDER
D300**

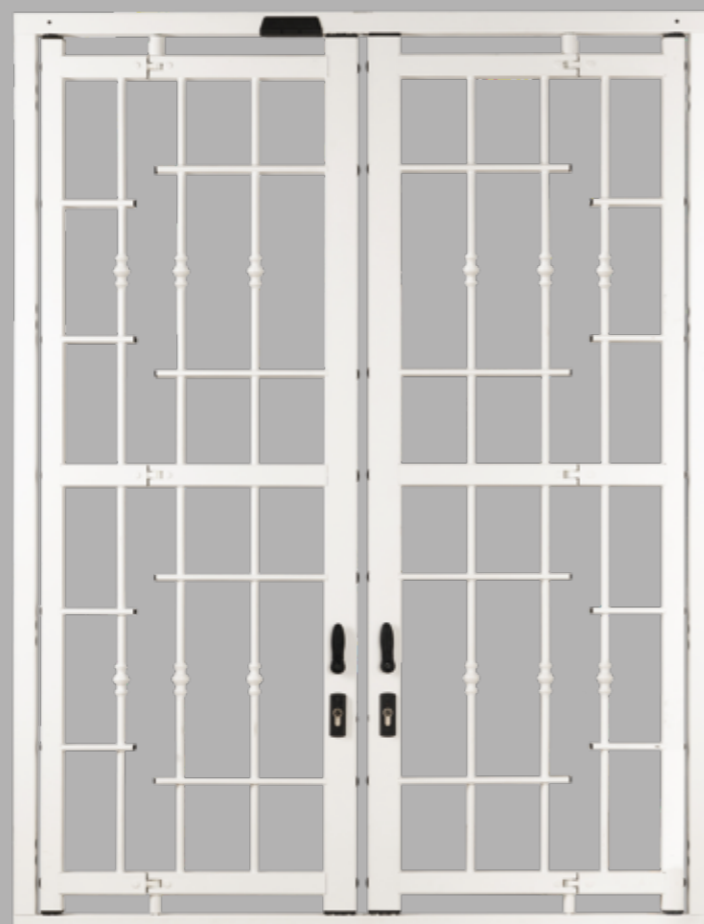

**PORTA FINESTRA
2 Ante 2 Snodi**

PORTE FENÊTRE À 2 VANTAUX
2 ARTICULATIONS

**FINESTRA
2 Ante 2 Snodi**

FENÊTRE À 2 VANTAUX
2 ARTICULATIONS

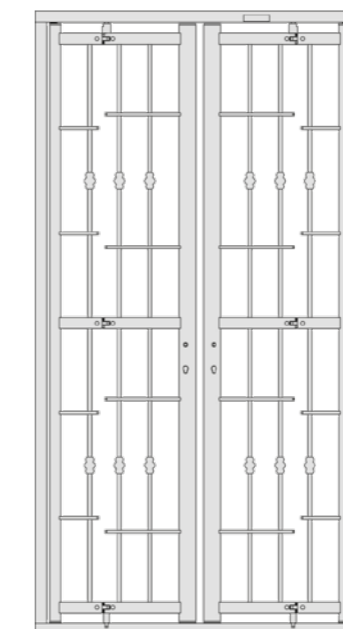
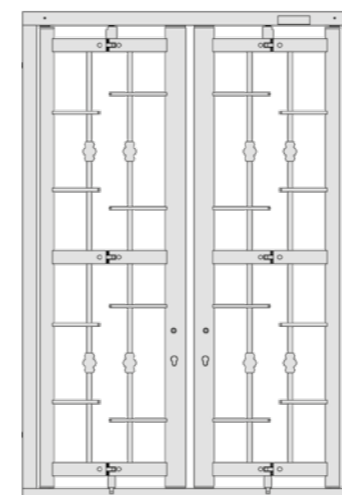

FISSA

FIXE

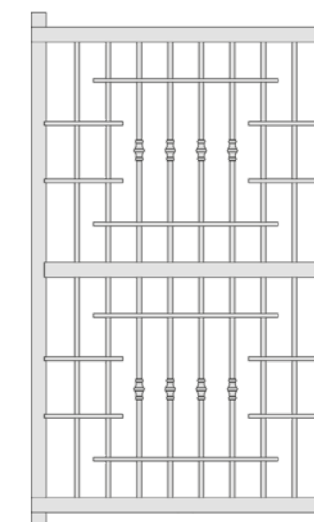

1 ANTA 2 SNODI
1 VANTAIL 2 ARTICULATIONS

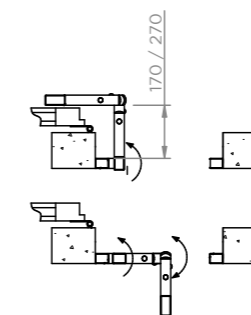

1 ANTA 1 SNODO
1 VANTAIL 1 ARTICULATION

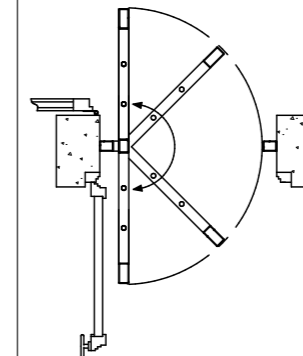

ANTA FISSA
VANTAIL FIX

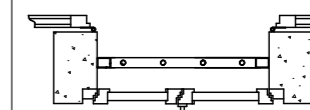

2 ANTE 2 SNODI
2 VANTAIL 2 ARTICULATIONS

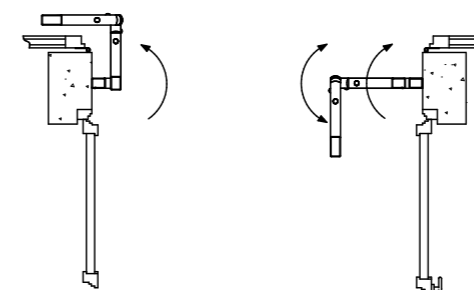

2 ANTE 1 SNODO
2 VANTAIL 1 ARTICULATIONS

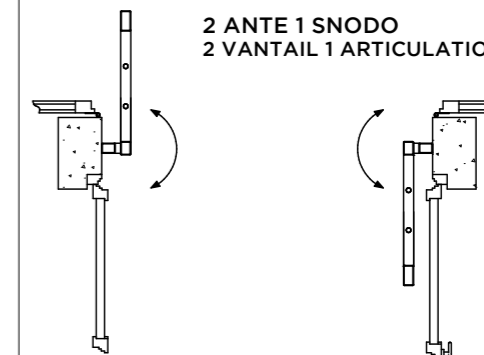

SOLUZIONI TECNICHE

SOLUTIONS TECHNIQUES

DEFENDER D400

CON D400 VANNO IN SCENA ELEMENTI DECORATIVI CHE RICHIAMANO L'ARTIGIANALITÀ DEL FERRO BATTUTO, MA CHE SONO COLLOCATI SU UN PRODOTTO DI ALTO LIVELLO TECNOLOGICO.



Avec le D400 montent sur scène des éléments décoratifs qui rappellent le savoir-faire du fer forgé, mais qui sont placés sur un produit high-tech. D400 est pour ceux qui aiment un style plus recherché.



NELLA FOTO: DEFENDER D400 - BARRA PIENA TONDA, VERDE RAFFAELLO
DANS LA PHOTO: DEFENDER D400 - BARRE RONDE COMPLÈTE - COULEUR VERT RAFFAELLO

**BARRA PIENA Ø14 MM
ALTERNATA A TUBO CON INSERTO
TONDINO CARBOCEMENTATO
ANTITAGLIO**

BARRE COMPLÈTE 14MM ALTERNÉE AVEC TUBE AVEC INSERT
ROND CARBOCÉMENTÉ' ANTI-COUPURE

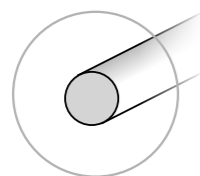

**BARRA PIENA
14X14 mm
NELLA VERSIONE
QUADRATA**

BARRE COMPLÈTE 14X14 MM
EN VERSION CARRÉE

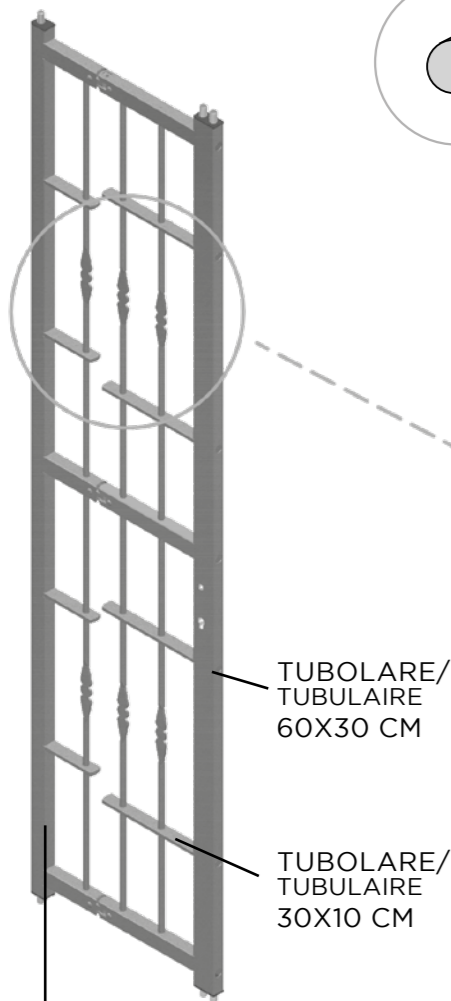
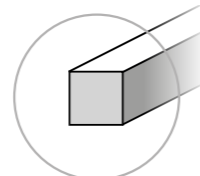

TUBOLARE/
TUBULAIRE
60X30 CM

TUBOLARE/
TUBULAIRE
30X10 CM

TUBOLARE/
TUBULAIRE
40X30 CM

**DEFENDER
D400**

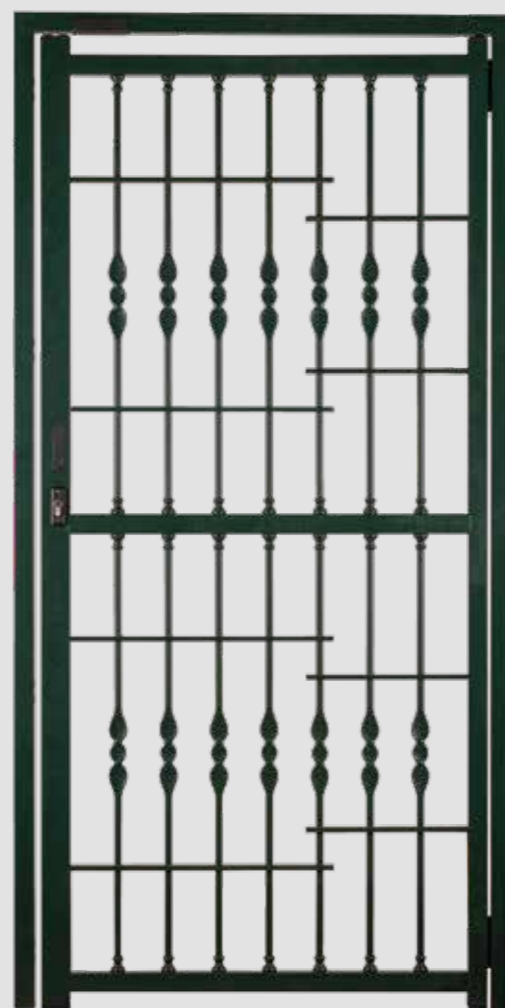

**PORTA FINESTRA
2 Ante 2 Snodi**

PORTE FENÊTRE À 2 VANTAUX
2 ARTICULATIONS

**FINESTRA
2 Ante 2 Snodi**

FENÊTRE À 2 VANTAUX
2 ARTICULATIONS

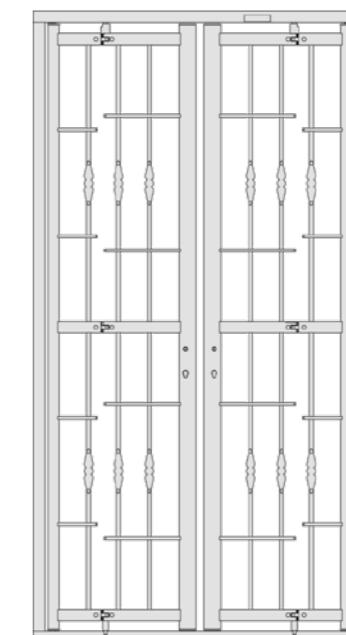
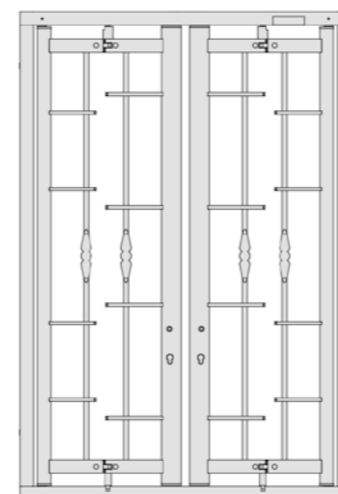

FISSA

FIXE

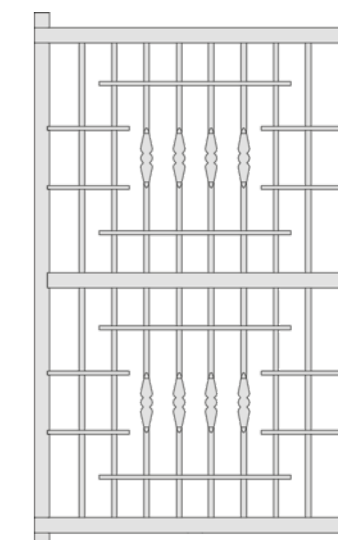

1 ANTA 2 SNODI
1 VANTAIL 2 ARTICULATIONS

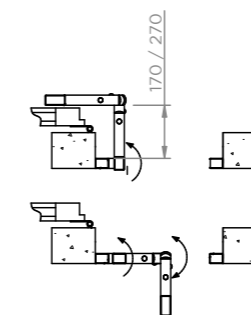

1 ANTA 1 SNODO
1 VANTAIL 1 ARTICULATION

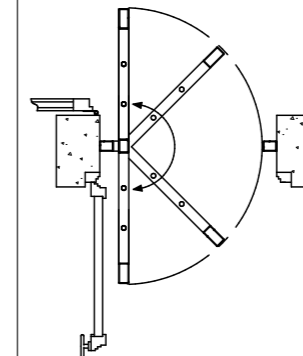

ANTA FISSA
VANTAIL FIX

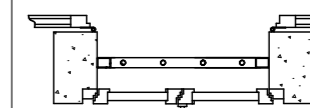

2 ANTE 2 SNODI
2 VANTAIL 2 ARTICULATIONS

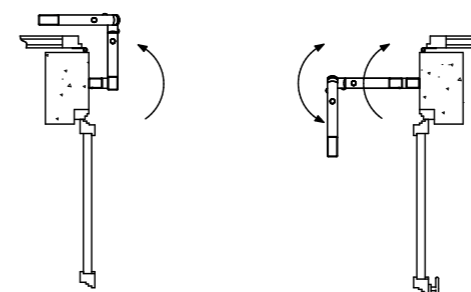

2 ANTE 1 SNODO
2 VANTAIL 1 ARTICULATIONS

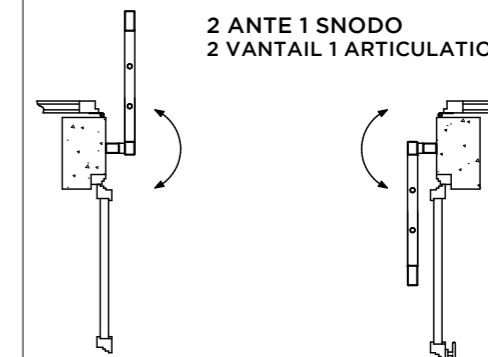

SOLUZIONI TECNICHE

SOLUTIONS TECHNIQUES

DEFENDER D500

D500 È UN MODELLO DAL DISEGNO RIGOROSO CHE, IMPREZIOSITO DAL DECORO CIRCOLARE SUPERIORE E INFERIORE, È IDEALE PER CONTESTI ABITATIVI DALLA SPICCATATA PERSONALITÀ.



D500 est un modèle avec un design rigoureux qui, agrémenté par la décoration circulaire supérieure et inférieure, est idéal pour lieux d'une grande personnalité.



NELLA FOTO: DEFENDER D500 - BARRA PIENA TONDA, MARRONE TDM GRINZ
DANS LA PHOTO: DEFENDER D500 - BARRE RONDE COMPLÈTE - COULEUR MARRON TDM GRINZ

**BARRA PIENA Ø14 MM
ALTERNATA A TUBO CON INSERTO
TONDINO CARBOCEMENTATO
ANTITAGLIO**

BARRE COMPLÈTE 14MM ALTERNÉE AVEC TUBE AVEC INSERT
ROND CARBOCÉMENTÉ' ANTI-COUPURE

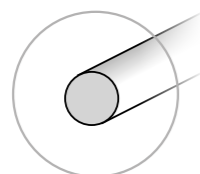

**BARRA PIENA
14X14 mm
NELLA VERSIONE
QUADRATA**

BARRE COMPLÈTE 14X14 MM
EN VERSION CARRÉE

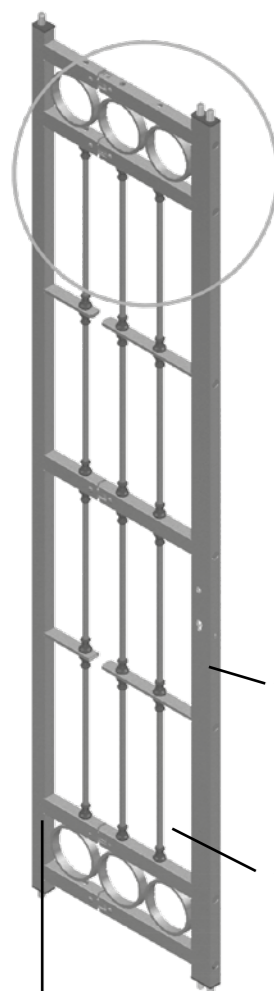
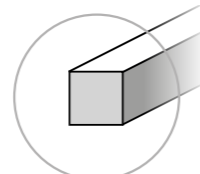

TUBOLARE/
TUBULAIRE
60X30 CM

TUBOLARE/
TUBULAIRE
30X10 CM

TUBOLARE/
TUBULAIRE
40X30 CM

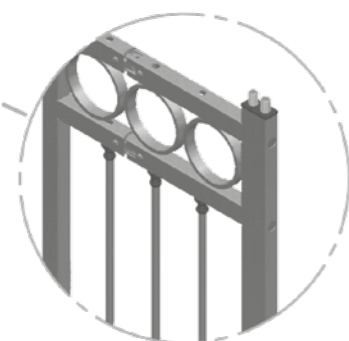

**DEFENDER
D500**

**PORTA FINESTRA
2 Ante 2 Snodi**

PORTE FENÊTRE À 2 VANTAUX
2 ARTICULATIONS

**FINESTRA
2 Ante 2 Snodi**

FENÊTRE À 2 VANTAUX
2 ARTICULATIONS

**FISSA
FIXE**

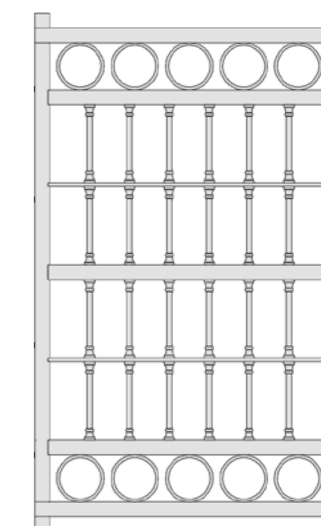
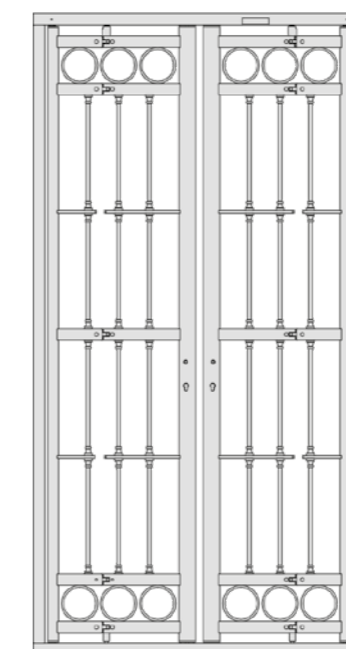
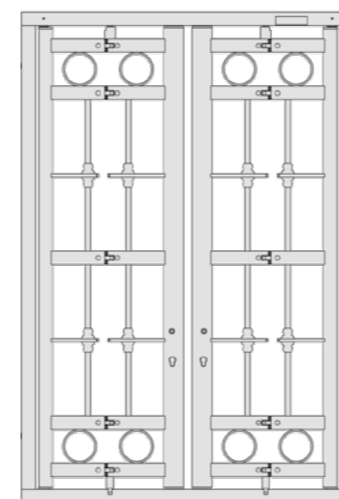

1 ANTA 2 SNODI
1 VANTAIL 2 ARTICULATIONS

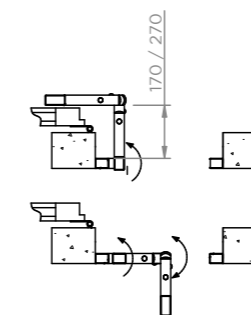

1 ANTA 1 SNODO
1 VANTAIL 1 ARTICULATION

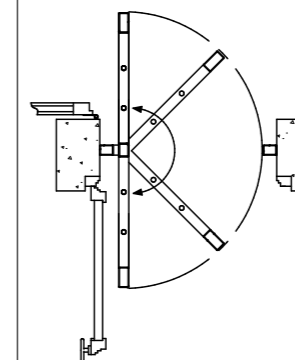

ANTA FISSA
VANTAIL FIX

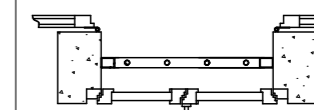

2 ANTE 2 SNODI
2 VANTAIL 2 ARTICULATIONS

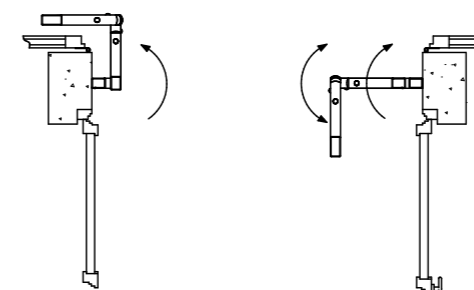

2 ANTE 1 SNODO
2 VANTAIL 1 ARTICULATIONS

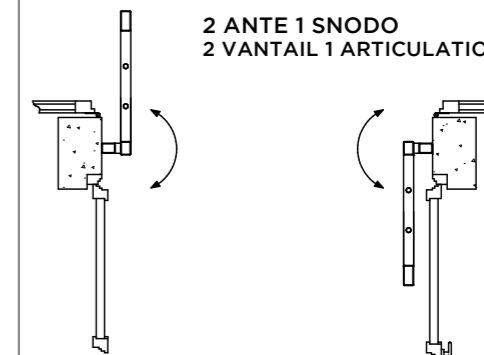

SOLUZIONI TECNICHE

SOLUTIONS TECHNIQUES

DEFENDER D600

D600 È LA PROVA DI COME UN DETTAGLIO POSSA TRASFORMARE UNA GRATA ANTIEFFRAZIONE IN UN PRODOTTO RICCO DI STILE ED ELEGANZA.



D600 démontre comment un détail peut transformer une grille de sécurité en un produit de style et d'élégance.



NELLA FOTO: DEFENDER D600 - BARRA PIENA TONDA, BIANCO GLITTER
DANS LA PHOTO: DEFENDER D600 - BARRE RONDE COMPLÈTE - COULEUR BLANC GLITTER

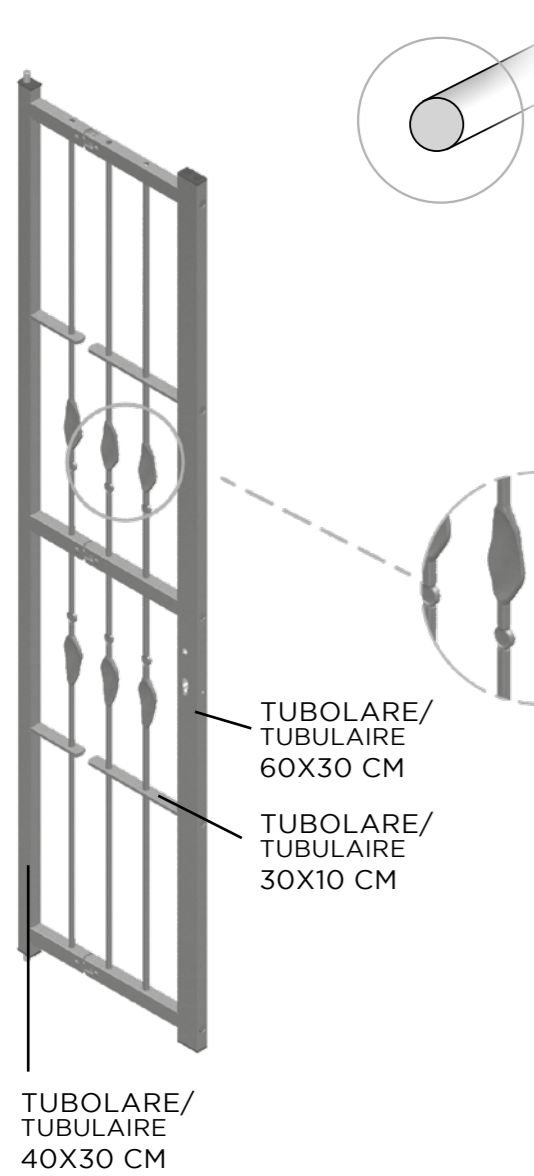

BARRA PIENA Ø14 MM
ALTERNATA A TUBO CON INSERTO
TONDINO CARBOCEMENTATO
ANTITAGLIO

BARRE COMPLÈTE 14MM ALTERNÉE AVEC TUBE AVEC INSERT
ROND CARBOCÉMENTÉ' ANTI-COUPURE

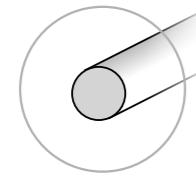

**BARRA PIENA
14X14 mm**
NELLA VERSIONE
QUADRATA

BARRE COMPLÈTE 14X14 MM
EN VERSION CARRÉE

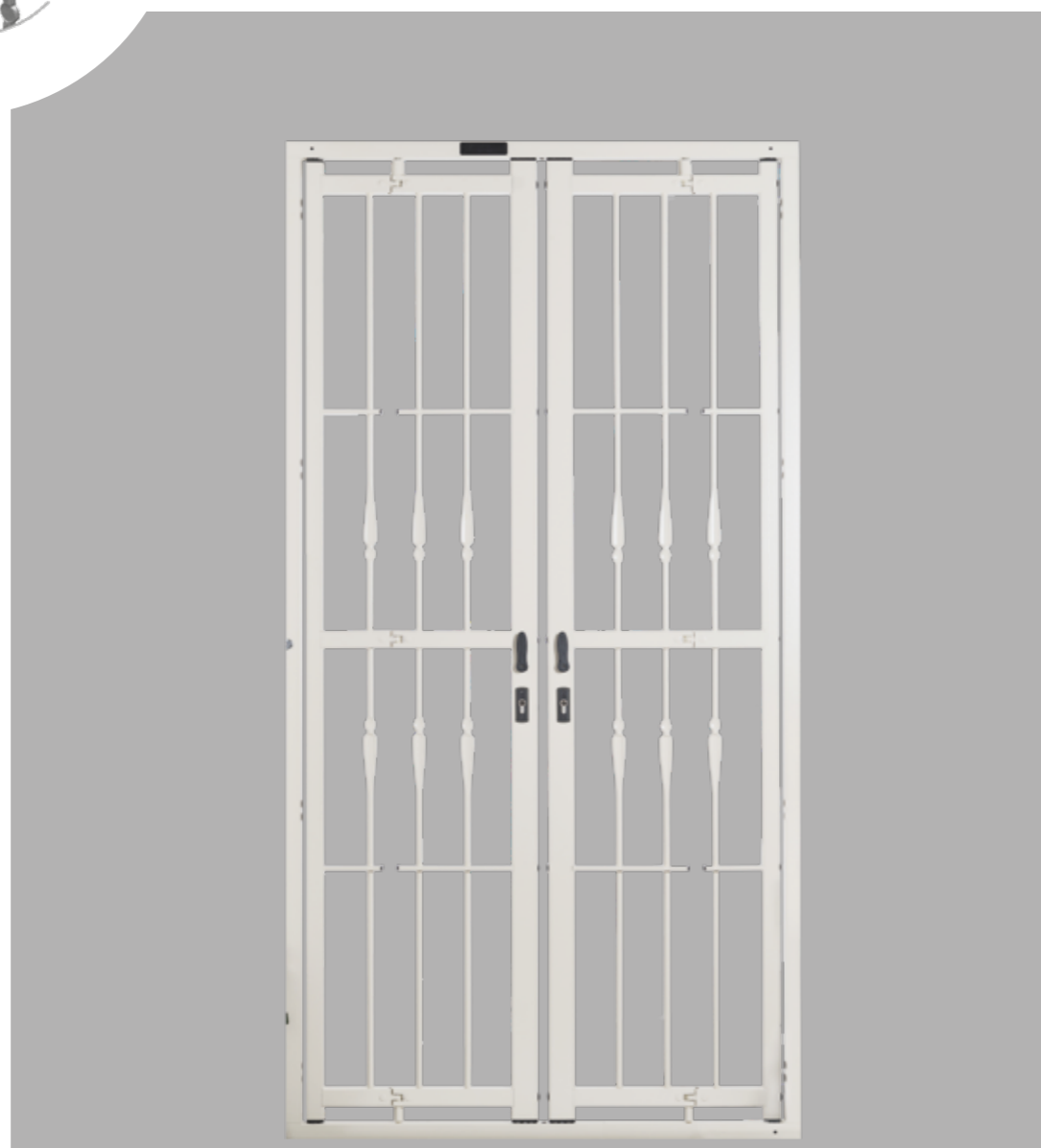
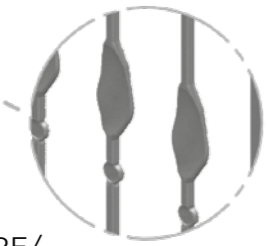
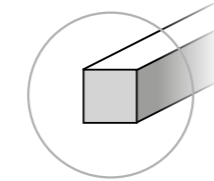

**DEFENDER
D600**

FINESTRA
2 Ante 2 Snodi
FENÊTRE À 2 VANTAUX
2 ARTICULATIONS

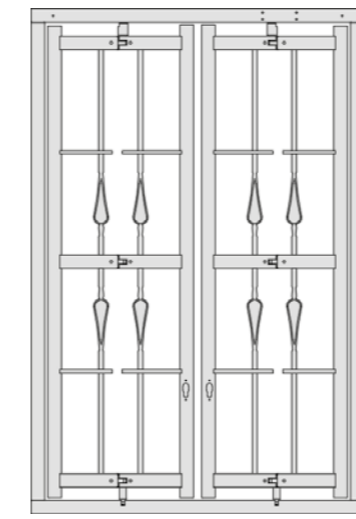

PORTA FINESTRA
2 Ante 2 Snodi
PORTE FENÊTRE À 2 VANTAUX
2 ARTICULATIONS

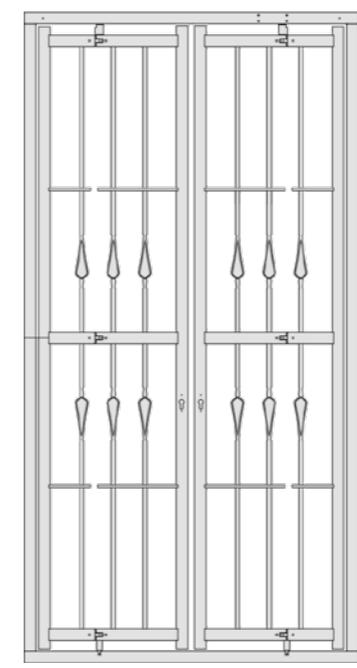

FISSA
FIXE

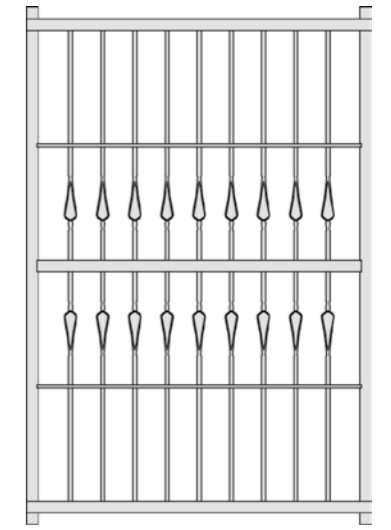

1 ANTA 2 SNODI
1 VANTAIL 2 ARTICULATIONS

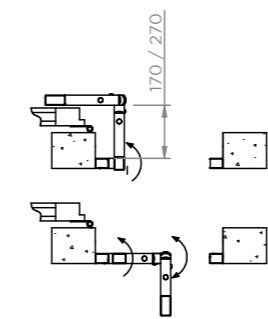

1 ANTA 1 SNODO
1 VANTAIL 1 ARTICULATION

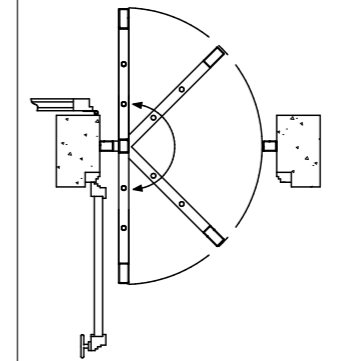

ANTA FISSA
VANTAIL FIX

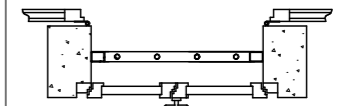

2 ANTE 2 SNODI
2 VANTAIL 2 ARTICULATIONS

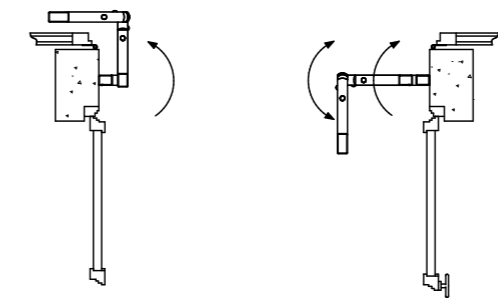

2 ANTE 1 SNODO
2 VANTAIL 1 ARTICULATIONS

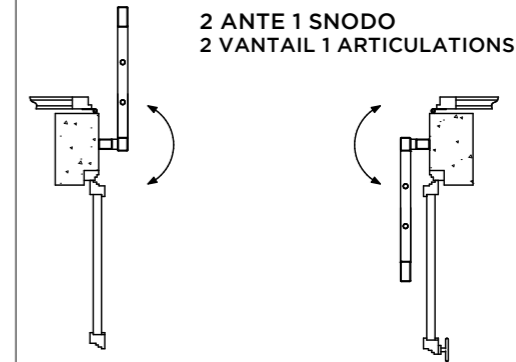

SOLUZIONI TECNICHE

SOLUTIONS TECHNIQUES

DEFENDER D700

CON IL DECORO A SPIRALE, D700 È L'ESEMPIO DI COME ALIAS ABBIAMO RICERCATO GLI ELEMENTI PIÙ ORIGINALI DA INSERIRE NELLE PROPRIE GRATE PER SODDISFARE SVARIATE ESIGENZE ESTETICHE.



Avec le décor en forme de spirale, D700 recherche les éléments les plus originaux pour des grilles et ça permet de répondre à divers besoins esthétiques.



NELLA FOTO: DEFENDER D700 - BARRA PIENA QUADRATA, GRIGIO GLITTER
DANS LA PHOTO: DEFENDER D700 - BARRE CARRÉE COMPLETE - COULEUR GRIS GLITTER

**BARRA PIENA Ø14 MM
ALTERNATA A TUBO CON INSERTO
TONDINO CARBOCEMENTATO
ANTITAGLIO**

BARRE COMPLÈTE 14MM ALTERNÉE AVEC TUBE AVEC INSERT
ROND CARBOCÉMENTÉ' ANTI-COUPURE

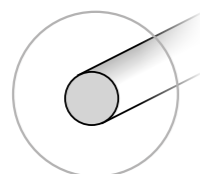

**BARRA PIENA
14X14 mm
NELLA VERSIONE
QUADRATA**

BARRE COMPLÈTE 14X14 MM
EN VERSION CARRÉE

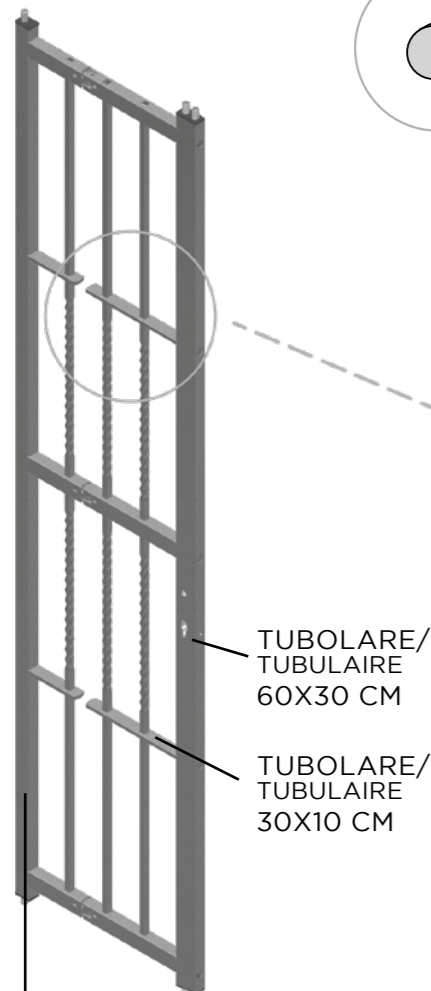
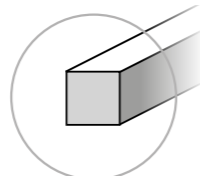

TUBOLARE/
TUBULAIRE
60X30 CM

TUBOLARE/
TUBULAIRE
30X10 CM

TUBOLARE/
TUBULAIRE
40X30 CM

**DEFENDER
D700**



**FINESTRA
2 Ante 2 Snodi**

FENÊTRE À 2 VANTAUX
2 ARTICULATIONS

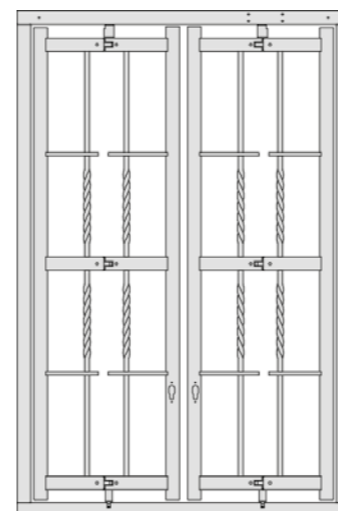

**PORTA FINESTRA
2 Ante 2 Snodi**

PORTE FENÊTRE À 2 VANTAUX
2 ARTICULATIONS

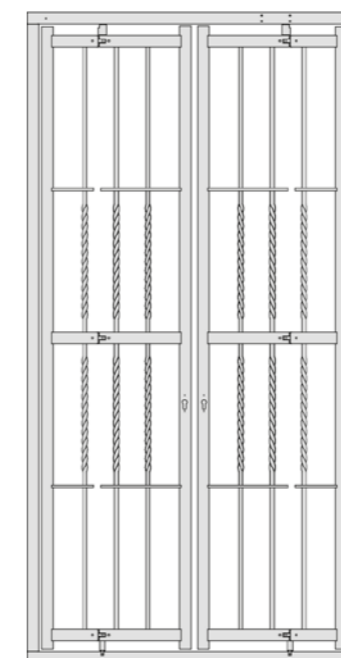

**FISSA
FIXE**

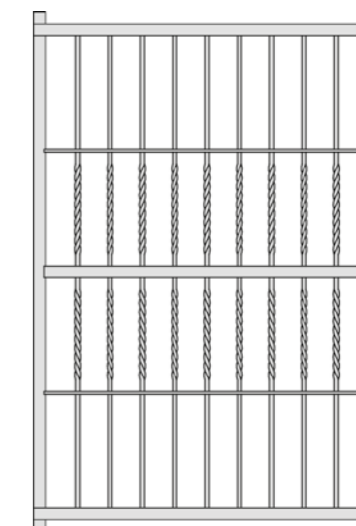

1 ANTA 2 SNODI
1 VANTAIL 2 ARTICULATIONS

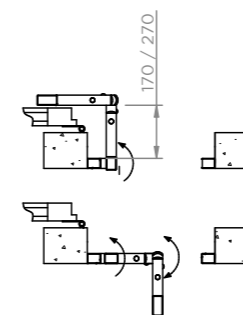

1 ANTA 1 SNODO
1 VANTAIL 1 ARTICULATION

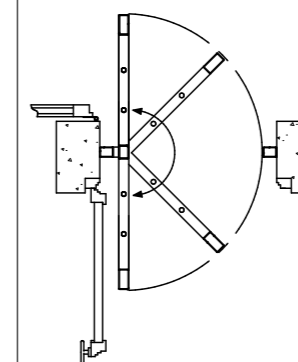

ANTA FISSA
VANTAIL FIX

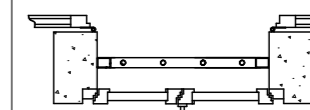

2 ANTE 2 SNODI
2 VANTAIL 2 ARTICULATIONS

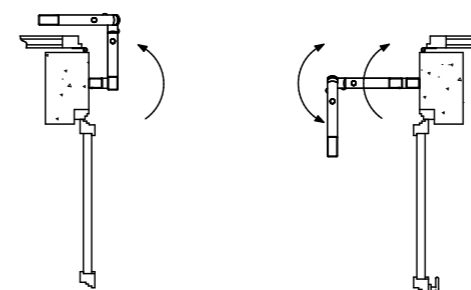

2 ANTE 1 SNODO
2 VANTAIL 1 ARTICULATIONS

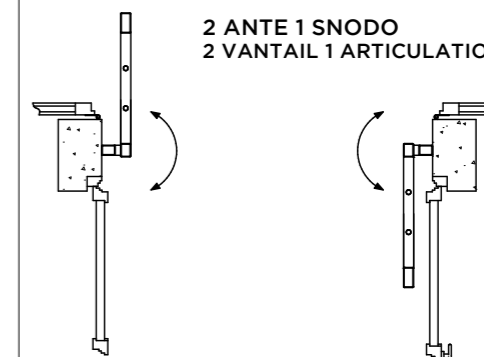

SOLUZIONI TECNICHE

SOLUTIONS TECHNIQUES

DEFENDER D800

IN D800 UNA LINEA SPEZZATA NELLA SUA REGOLARITÀ VIVACIZZA L'ESTETICA, CHE SI ABBINA ALLA ROBUSTEZZA E ALLA SICUREZZA DELLA GRATA DEFENDER.



Dans le D800, une ligne brisée dans sa régularité anime l'esthétique, qui se conjugue avec la solidité et la sécurité de la grille Defender.



NELLA FOTO: DEFENDER D800 - BARRA PIENA QUADRATA, BIANCO GLITTER
DANS LA PHOTO: DEFENDER D800 - BARRE CARRÉE COMPLÈTE - COULEUR BLANC GLITTER

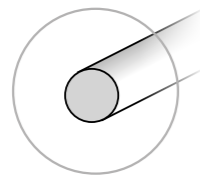
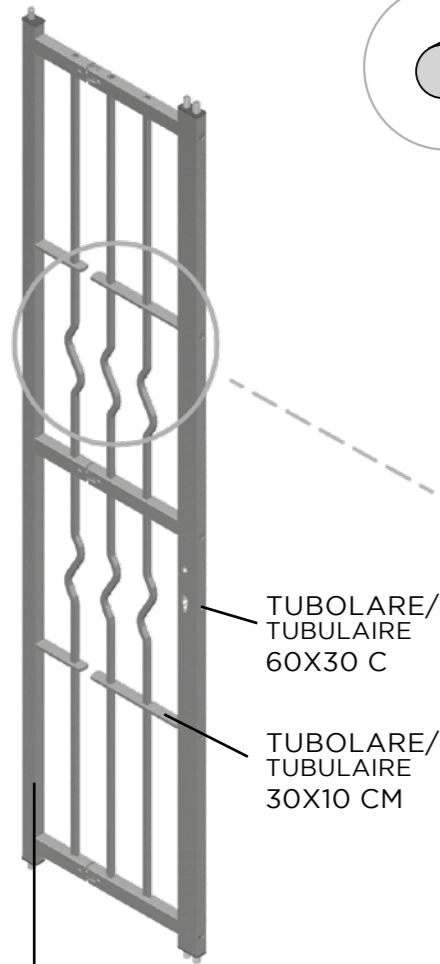

**BARRA PIENA Ø14 MM
ALTERNATA A TUBO CON INSERTO
TONDINO CARBOCEMENTATO
ANTITAGLIO**

BARRE COMPLÈTE 14MM ALTERNÉE AVEC TUBE AVEC INSERT
ROND CARBOCÉMENTÉ' ANTI-COUPURE

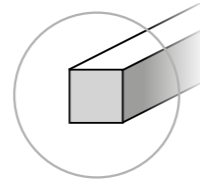
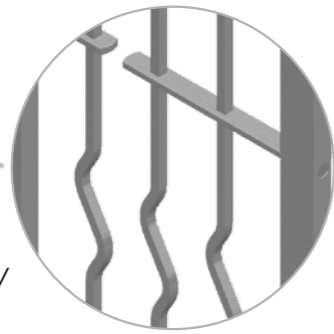

**BARRA PIENA
14X14 mm
NELLA VERSIONE
QUADRATA**

BARRE COMPLÈTE 14X14 MM
EN VERSION CARRÉE

TUBOLARE/
TUBULAIRE
60X30 C

TUBOLARE/
TUBULAIRE
30X10 CM

TUBOLARE/
TUBULAIRE
40X30 CM

**DEFENDER
D800**

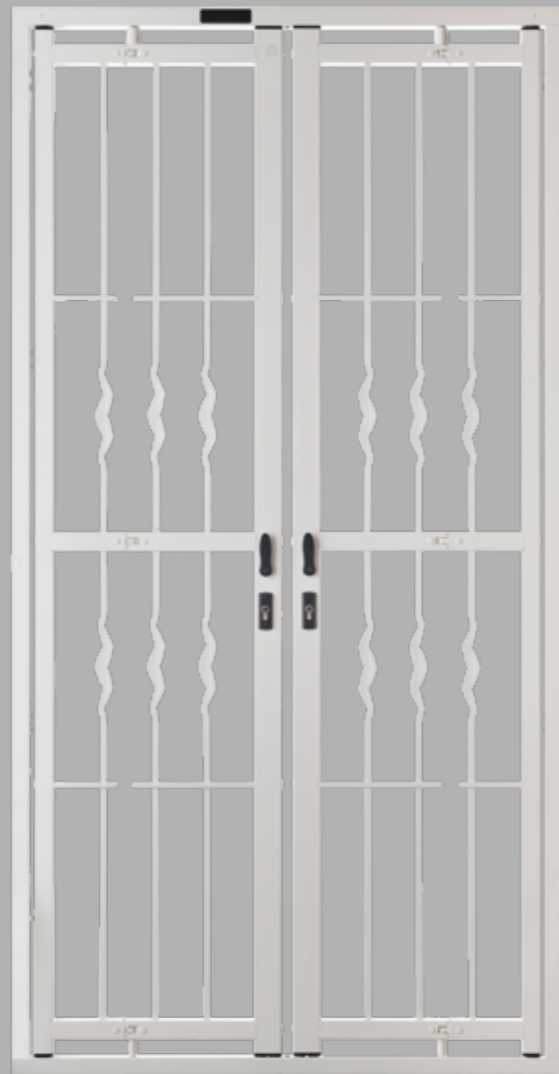

**FINESTRA
2 Ante 2 Snodi**

FENÊTRE À 2 VANTAUX
2 ARTICULATIONS

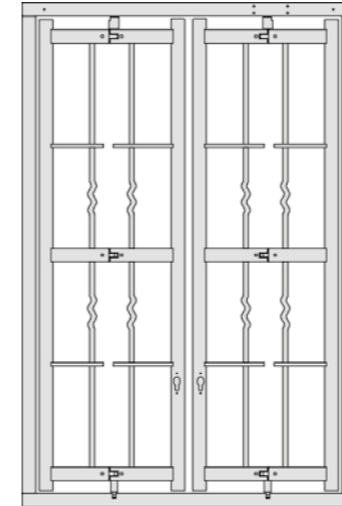

**PORTA FINESTRA
2 Ante 2 Snodi**

PORTE FENÊTRE À 2 VANTAUX
2 ARTICULATIONS

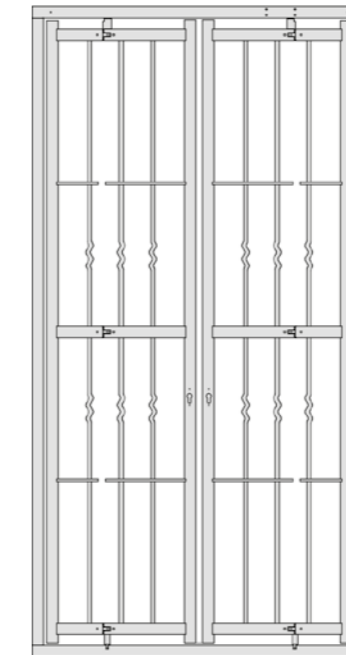

**FISSA
FIXE**

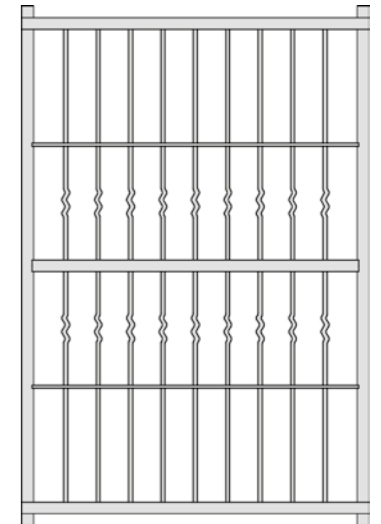

**1 ANTA 2 SNODI
1 VANTAIL 2 ARTICULATIONS**

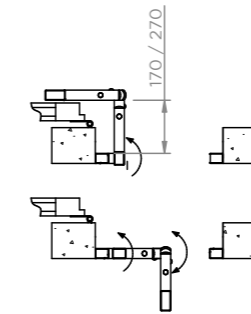

**1 ANTA 1 SNODO
1 VANTAIL 1 ARTICULATION**

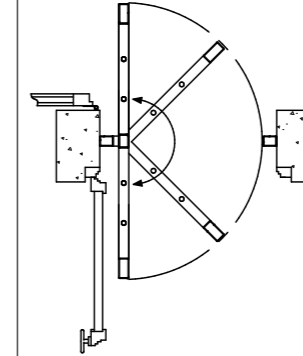

**ANTA FISSA
VANTAIL FIX**

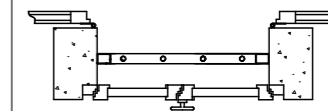

**2 ANTE 2 SNODI
2 VANTAIL 2 ARTICULATIONS**

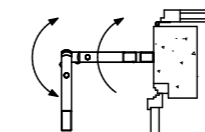
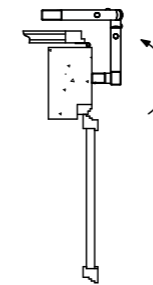

**2 ANTE 1 SNODO
2 VANTAIL 1 ARTICULATIONS**

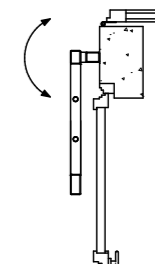
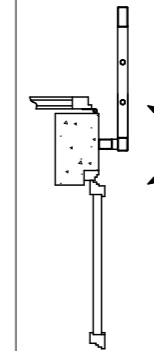

SOLUZIONI TECNICHE

SOLUTIONS TECHNIQUES

DEFENDER D900

D900 È PER CHI HA NECESSITÀ DI PROTEGGERE LA PROPRIA CASA, AVVALENDOSI DI UN ELEMENTO TECNICO DI DESIGN.

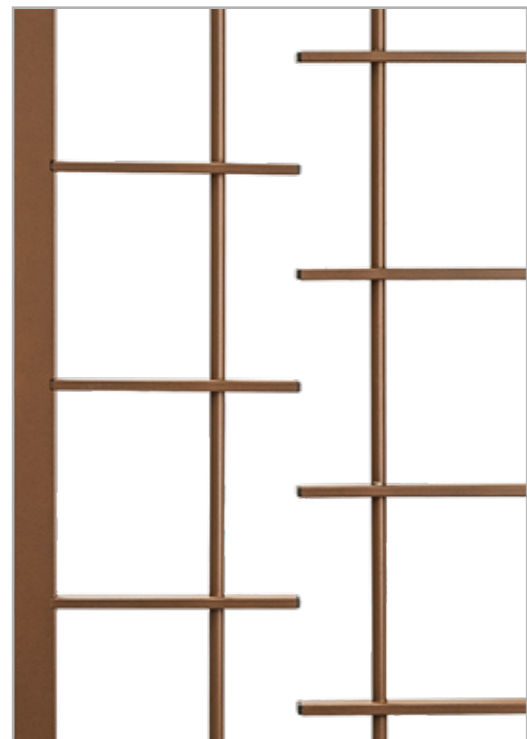

D900 est pour ceux qui ont besoin de protéger leur maison, en utilisant un élément de conception technique.



NELLA FOTO: DEFENDER D900 - BARRA PIENA QUADRATA, RUGGINE
DANS LA PHOTO: DEFENDER D900 - BANDE CARRÉE COMPLÈTE - COULEUR ROUILLER

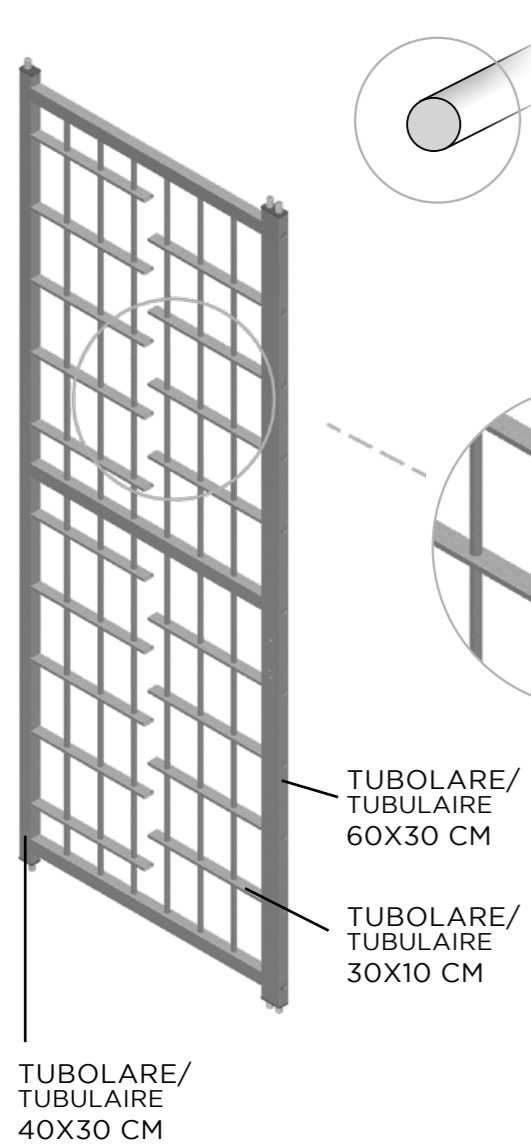

**BARRA PIENA Ø14 MM
ALTERNATA A TUBO CON INSERTO
TONDINO CARBOCEMENTATO
ANTITAGLIO**

BARRE COMPLÈTE 14MM ALTERNÉE AVEC TUBE AVEC INSERT
ROND CARBOCÉMENTÉ' ANTI-COUPURE

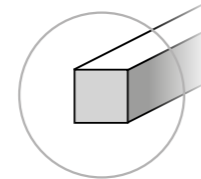
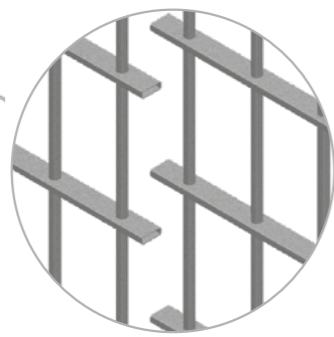
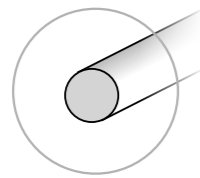

**BARRA PIENA
14X14 mm
NELLA VERSIONE
QUADRATA**

BARRE COMPLÈTE 14X14 MM
EN VERSION CARRÉE

**DEFENDER
D900**



**FINESTRA
2 Ante 2 Snodi**

FENÊTRE À 2 VANTAUX
2 ARTICULATIONS

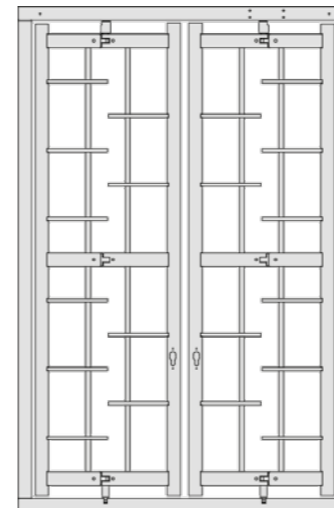

**PORTA FINESTRA
2 Ante 2 Snodi**

PORTE FENÊTRE À 2 VANTAUX
2 ARTICULATIONS

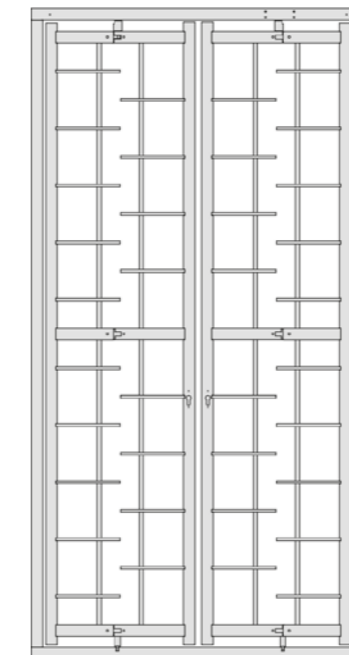

**FISSA
FIXE**

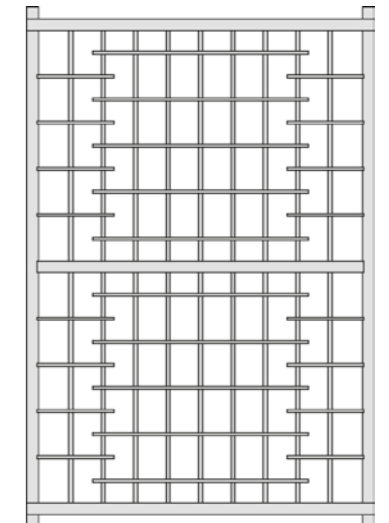

1 ANTA 2 SNODI
1 VANTAIL 2 ARTICULATIONS

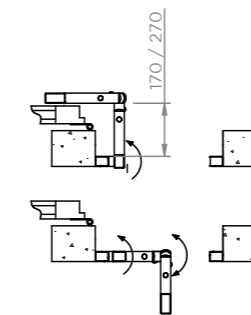

1 ANTA 1 SNODO
1 VANTAIL 1 ARTICULATION

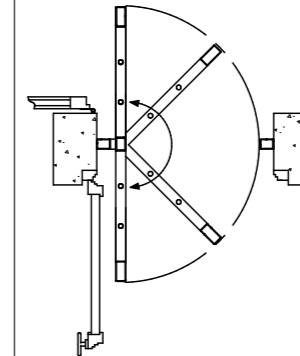

ANTA FISSA
VANTAIL FIX

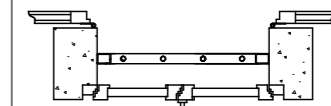

2 ANTE 2 SNODI
2 VANTAIL 2 ARTICULATIONS

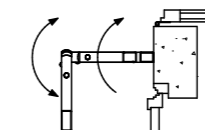
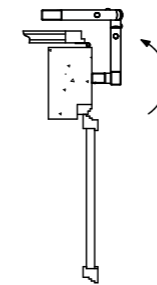

2 ANTE 1 SNODO
2 VANTAIL 1 ARTICULATIONS

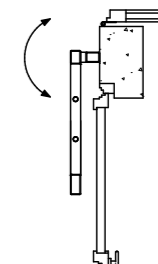
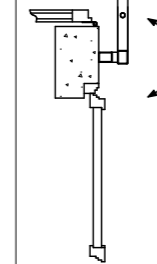

SOLUZIONI TECNICHE

SOLUTIONS TECHNIQUES

DEFENDER D1000

D1000 DISEGNA UNA FITTA GRIGLIA, PER CHI AMA LE LINEE ORIZZONTALI E VERTICALI.
UN CONCETTO DI GRATA CONTEMPORANEA DALLE LINEE RIGOROSE.

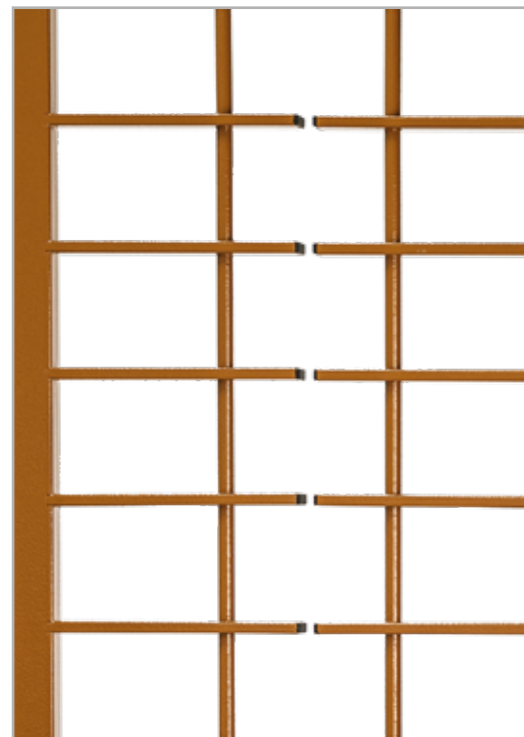

D1000 dessine une grille épaisse, pour ceux qui aiment les lignes horizontales et verticales.
Un concept de grille contemporaine aux lignes rigoureuses.



NELLA FOTO: DEFENDER D1000 - BARRA PIENA QUADRATA, RAL 8003
DANS LA PHOTO: DEFENDER D1000 - BANDE CARRÉE COMPLÈTE - COULEUR RAL 8003

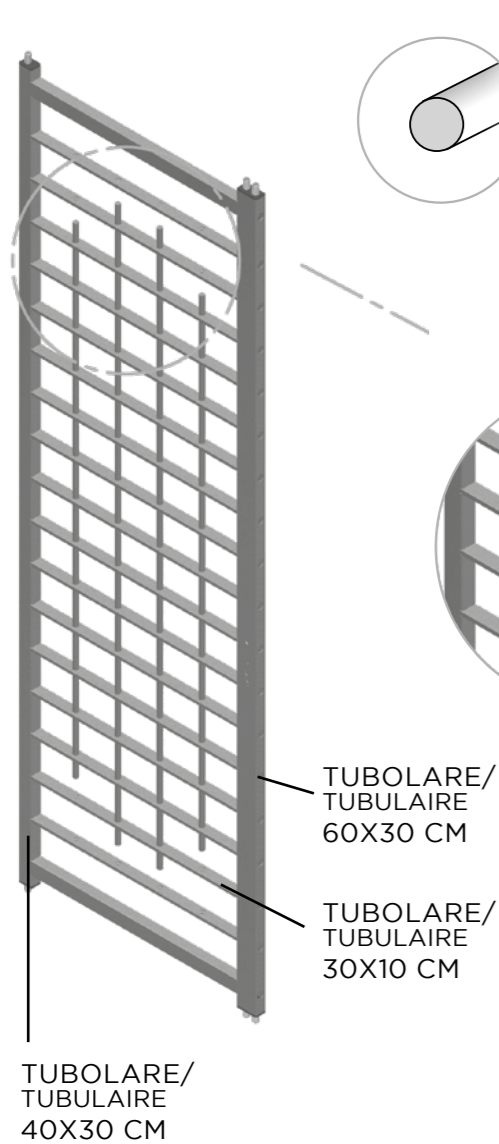

**BARRA PIENA Ø14 MM
ALTERNATA A TUBO CON INSERTO
TONDINO CARBOCEMENTATO
ANTITAGLIO**

BARRE COMPLÈTE 14MM ALTERNÉE AVEC TUBE AVEC INSERT
ROND CARBOCÉMENTÉ' ANTI-COUPURE

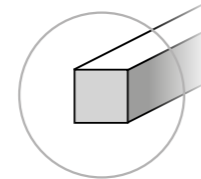
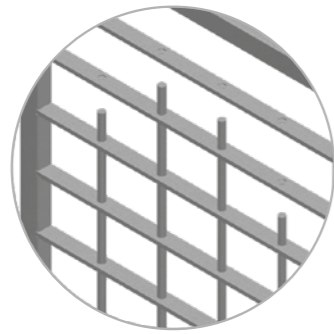
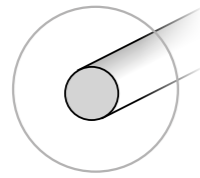

**BARRA PIENA
14X14 mm
NELLA VERSIONE
QUADRATA**

BARRE COMPLÈTE 14X14 MM
EN VERSION CARRÉE

**DEFENDER
D1000**

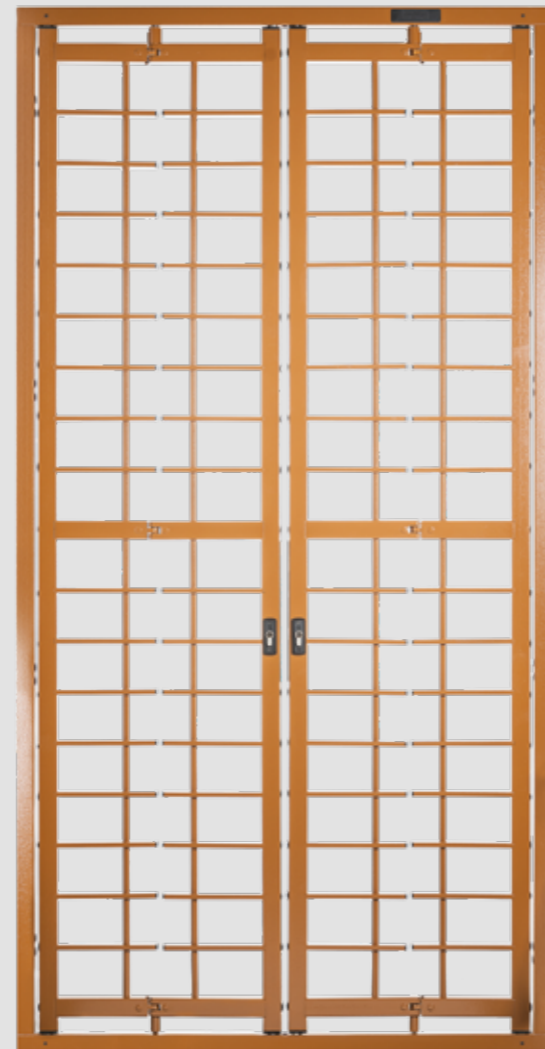

**FINESTRA
2 Ante 1 Snodo**
FENÊTRE À 2 VANTAUX
1 ARTICULATION

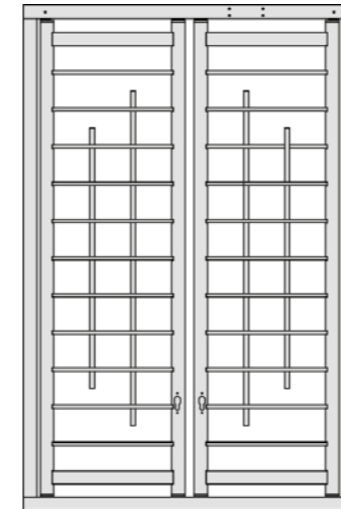

**FINESTRA
2 Ante 2 Snodi**
FENÊTRE À 2 VANTAUX
2 ARTICULATIONS

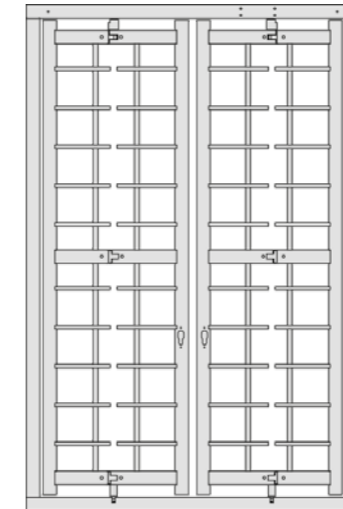

**PORTA FINESTRA
2 Ante 2 Snodi**
PORTE FENÊTRE À 2 VANTAUX
2 ARTICULATIONS

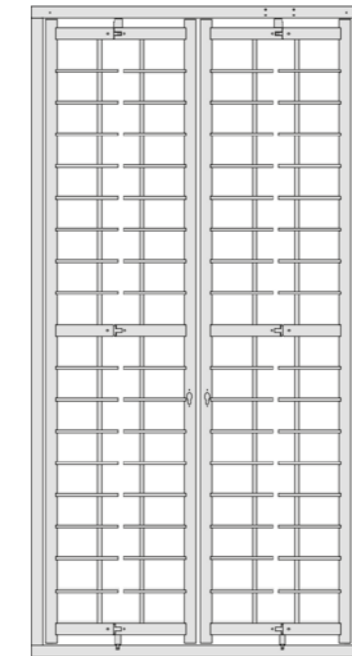

**FISSA
FIXE**

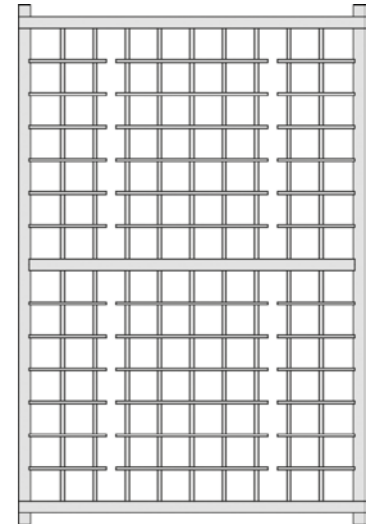

**1 ANTA 2 SNODI
1 VANTAIL 2 ARTICULATIONS**

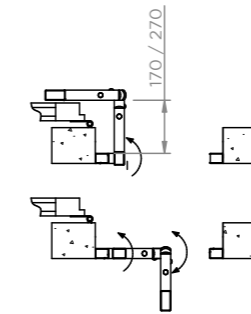

**1 ANTA 1 SNODO
1 VANTAIL 1 ARTICULATION**

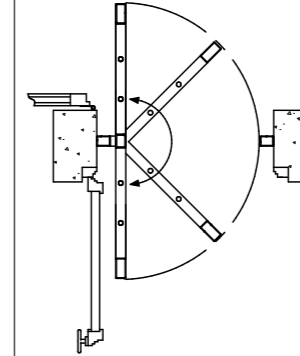

**ANTA FISSA
VANTAIL FIX**

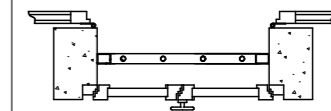

**2 ANTE 2 SNODI
2 VANTAIL 2 ARTICULATIONS**

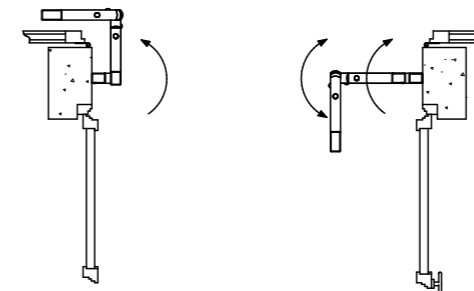

**2 ANTE 1 SNODO
2 VANTAIL 1 ARTICULATIONS**

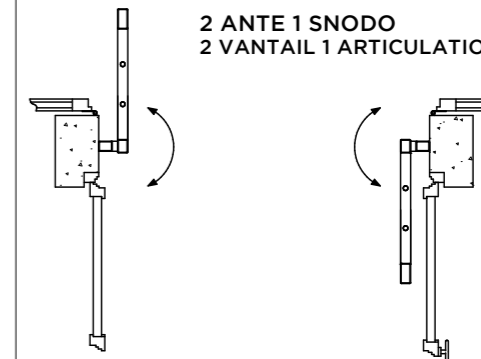

SOLUZIONI TECNICHE

SOLUTIONS TECHNIQUES

DEFENDER R100

R100 BEN SI INSERISCE IN CONTESTI ABITATIVI RURALI DAI SAPORI SPICCATAMENTE TRADIZIONALI. IL MOTIVO DECORATIVO INTERCALATO ED INTRECCIATO SULLE BARRE, RIPROPONE L'ATMOSFERA DELLE ANTICHE DIMORE RURALI DEL RINASCIMENTO E BAROCCO ITALIANO.

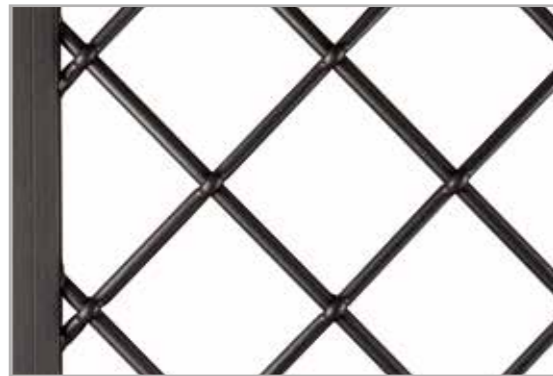

R100 s'intègre bien dans les contextes ruraux avec des saveurs distinctement traditionnels. Le motif décoratif entrelacé sur les barres recrée l'atmosphère des anciennes demeures rurales de la Renaissance et du Baroque italien.

DEFENDER R200

R200 SEGUE LA STESSA LINEA STILISTICA DI R100, BEN INSERENDOSI IN CONTESTI ABITATIVI RURALI. LE BARRE, CHE SI INTERSECANO PERPENDICOLARI TRA LORO E NON IN OBLIQUO, DONANDO PIÙ RIGORE ALL'ESTETICA DELL'EDIFICIO.



R200 suit la même ligne stylistique que R100, s'intégrant bien dans les milieux ruraux. Les barres, qui se croisent perpendiculairement les uns aux autres et non en oblique, donnent plus de rigueur à l'esthétique du bâtiment.



NELLA FOTO: DEFENDER R100 - BARRA PIENA QUADRATA, GRIGIO GLITTER
DANS LA PHOTO: DEFENDER R100 - BANDE CARREE COMPLETE - COULEUR GRIS GLITTER

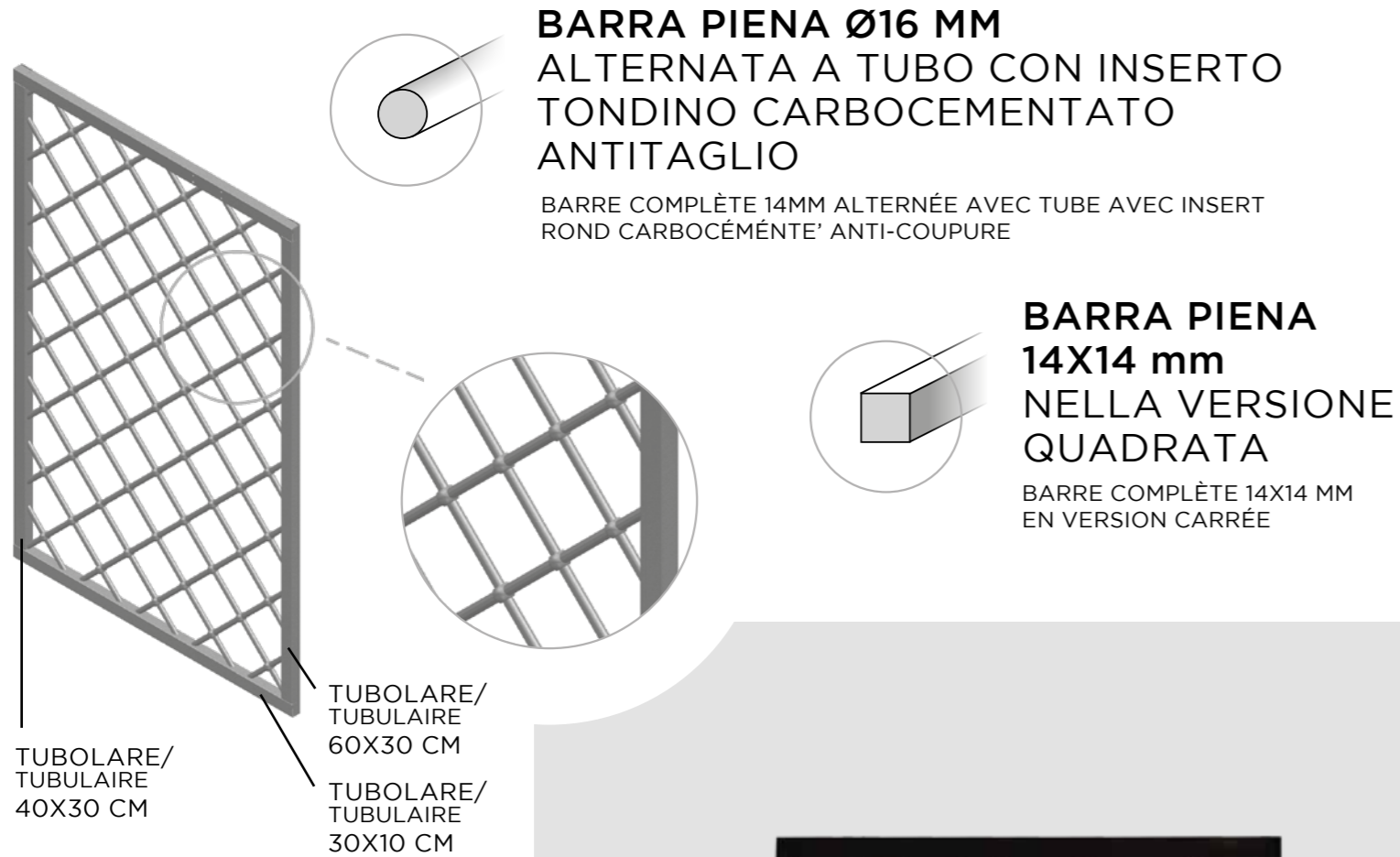

DEFENDER R100

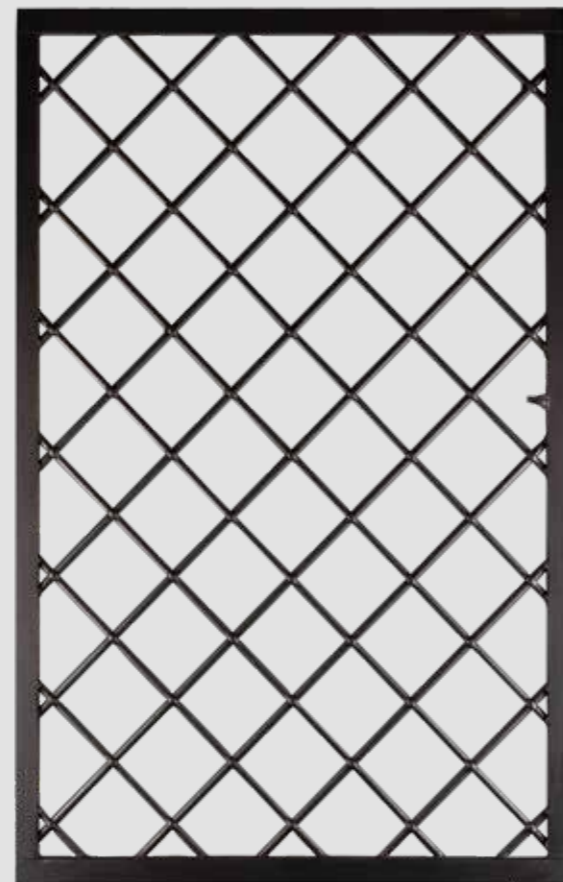

PORTA FINESTRA 1 Anta 1 Snodo

PORTE FENÊTRE À 2 VANTAUX
2 ARTICULATIONS

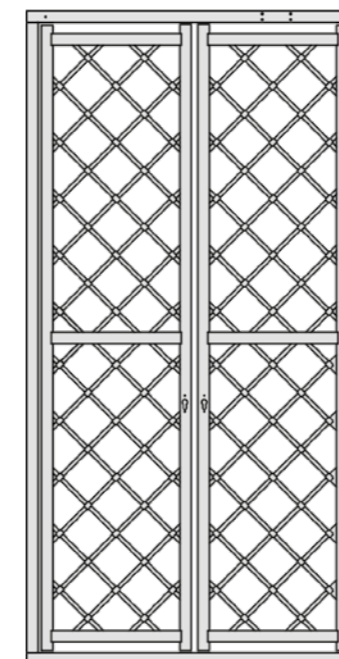

FISSA FIXE

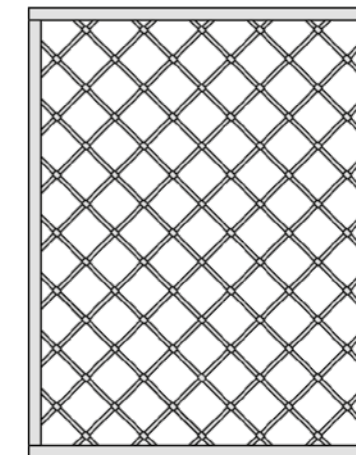

1 ANTA 1 SNODO
1 VANTAIL 1 ARTICULATION

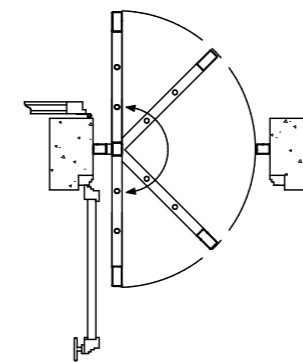

ANTA FISSA
VANTAIL FIX

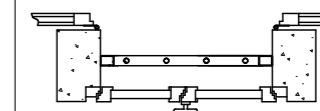

2 ANTE 1 SNODO
2 VANTAIL 1 ARTICULATIONS

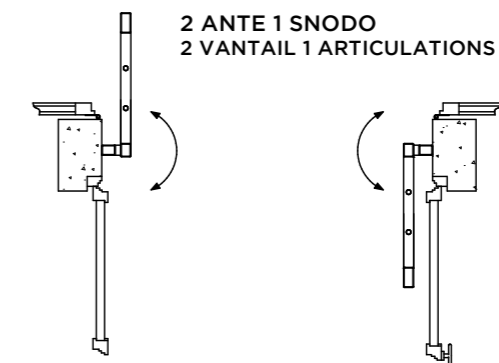

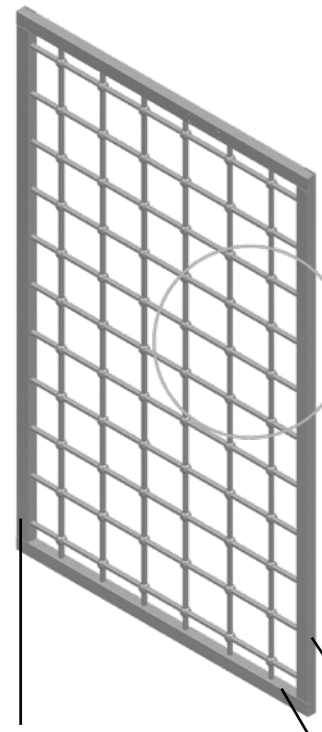

TUBOLARE/
TUBULAIRE
40X30 CM

TUBOLARE/
TUBULAIRE
60X30 CM

TUBOLARE/
TUBULAIRE
30X10 CM

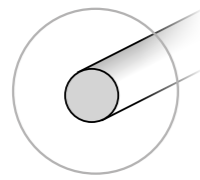

BARRA PIENA Ø16 MM
ALTERNATA A TUBO CON INSERTO
TONDINO CARBOCEMENTATO
ANTITAGLIO

BARRE COMPLÈTE 14MM ALTERNÉE AVEC TUBE AVEC INSERT
ROND CARBOCÉMENTÉ' ANTI-COUPURE

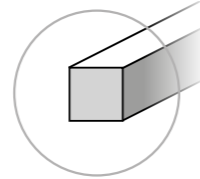
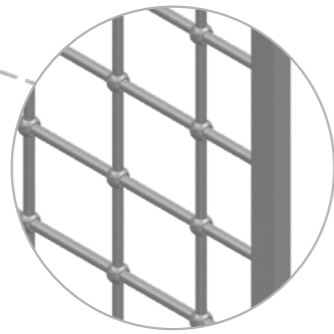

BARRA PIENA
14X14 mm
NELLA VERSIONE
QUADRATA

BARRE COMPLÈTE 14X14 MM
EN VERSION CARRÉE

DEFENDER
R200

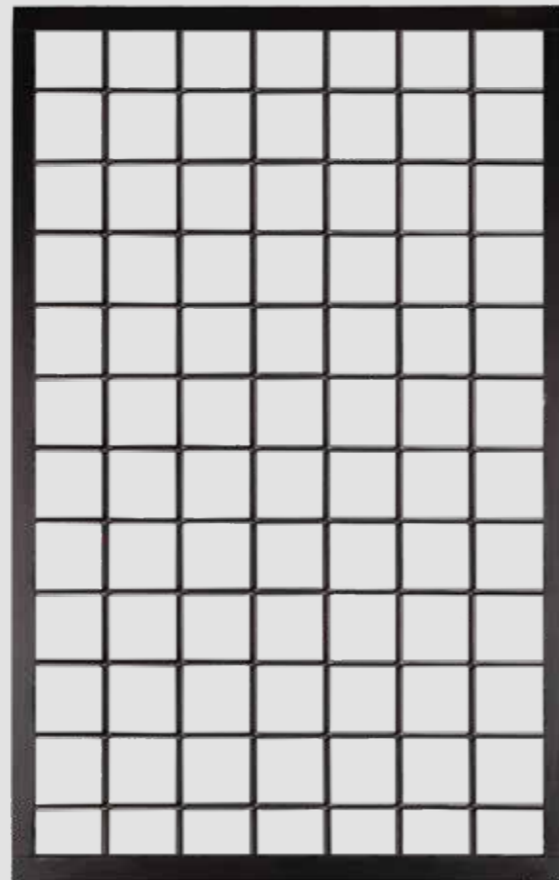

PORTA FINESTRA
1 Anta 1 Snodo

PORTE FENÊTRE À 2 VANTAUX
2 ARTICULATIONS

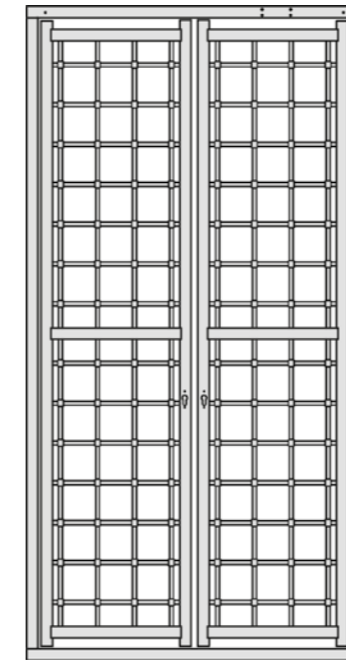

FISSA
FIXE

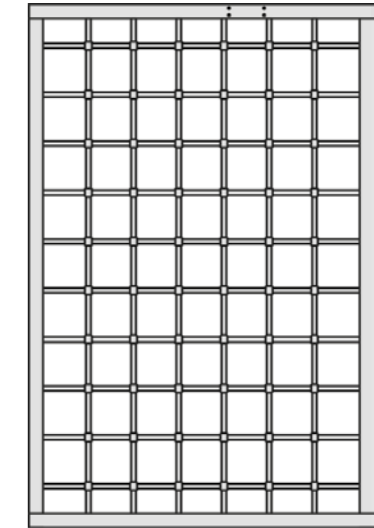

1 ANTA 1 SNODO
1 VANTAIL 1 ARTICULATION

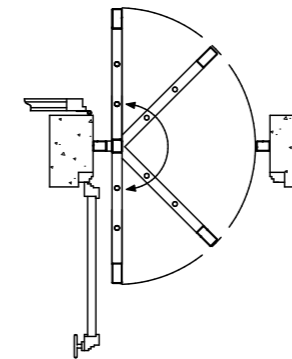

ANTA FISSA
VANTAIL FIX

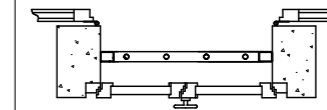

2 ANTE 1 SNODO
2 VANTAIL 1 ARTICULATIONS

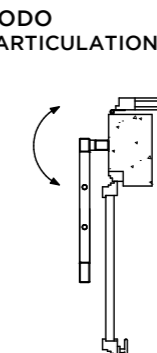
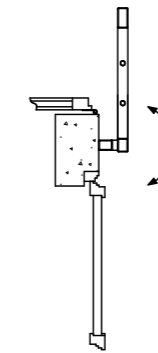

SOLUZIONI TECNICHE

SOLUTIONS TECHNIQUES

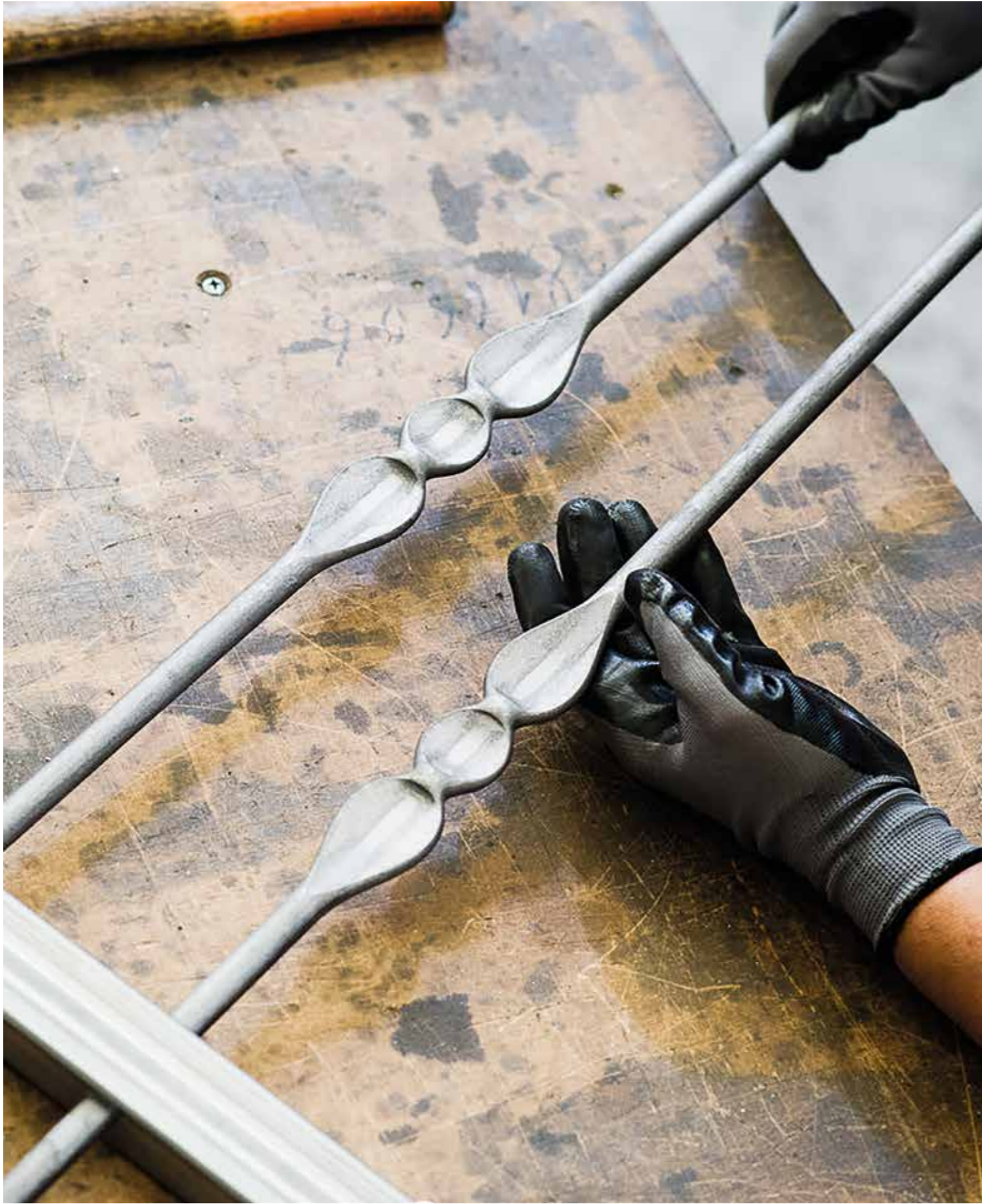

LINEA
DEFENDER
A TRE ANTE

DEFENDER A TRE ANTE CON APERTURA A LIBRO

UNA SOLUZIONE SPECIALE PENSATA PER LA SICUREZZA DELLE GRANDI APERTURE. GRATE A 3 ANTE DOTATE DI APERTURE CON SNODI, FISSE O A LIBRO. TUTTI I MODELLI DELLA GAMMA DEFENDER SONO REALIZZABILI CON QUESTA SOLUZIONE OTTIMA NEI CASI IN CUI SI HANNO LUCI MOLTO LARGHE. IN QUESTI CASI VIENE INSERITA UNA CERNIERA A VISTA CHE CONSENTE UN'APERTURA TOTALE A 180° PER SFRUTTARE AL MASSIMO IL PASSAGGIO.

DEFENDER AVEC TROIS VANTAUX AVEC OUVERTURE A LIVRE. Une solution spéciale conçue pour la sécurité des grandes ouvertures. Grilles 3 vantaux équipées d'articulations, ouvertures fixes ou a livre. Tous les modèles de la gamme Defender sont réalisables avec cette excellente solution dans les cas où le passage est très grand. Dans ces cas on ajoute une charnière visible pour permettre une ouverture totale à 180 pour profiter de tout l'espace.

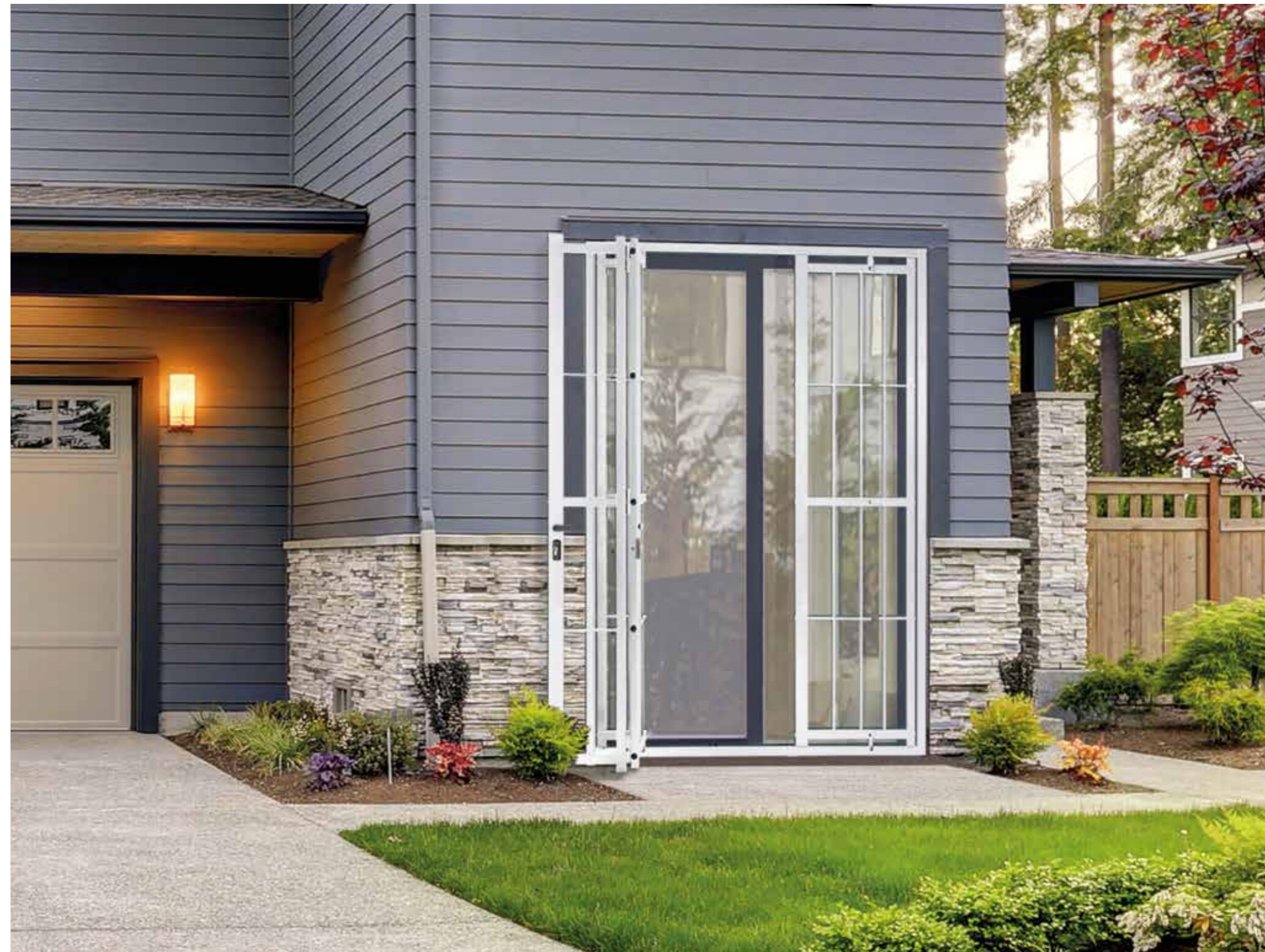

ESEMPIO DI COMBINAZIONE -
MA E' POSSIBILE COMBINARE ANCHE ANTE FISSE
CON ANTE APRIBILI.
EXEMPLE DE COMBINAISON -
MAIS IL EST POSSIBLE DE COMBINER AUSSI DES VANTAUX FIXES
AVEC VANTAUX OUVRANTS.

LE CERNIERE A VISTA CONSENTONO UN'APERTURA TOTALE A 180°. IL TAGLIO LASER, COME PER TUTTE LE LINEE DELLE GRATE DI SICUREZZA FIRMATE ALIAS, DONA PRECISIONE ED ELEGANZA ALLE LINEE

Les charnières externes permettent une ouverture totale à 180 °.

La coupe au laser, comme pour toutes les grille de sécurité alias, donne précision et élégance aux lignes.

DEFENDER A TRE ANTE CON APERTURA A LIBRO

DEFENDER AVEC TROIS VANTAUX
AVEC OUVERTURE A LIVRE.

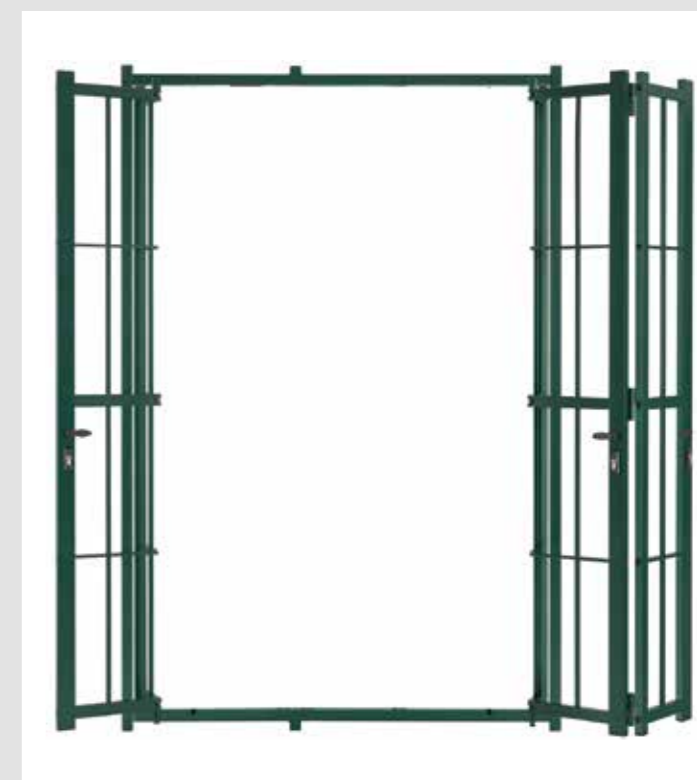
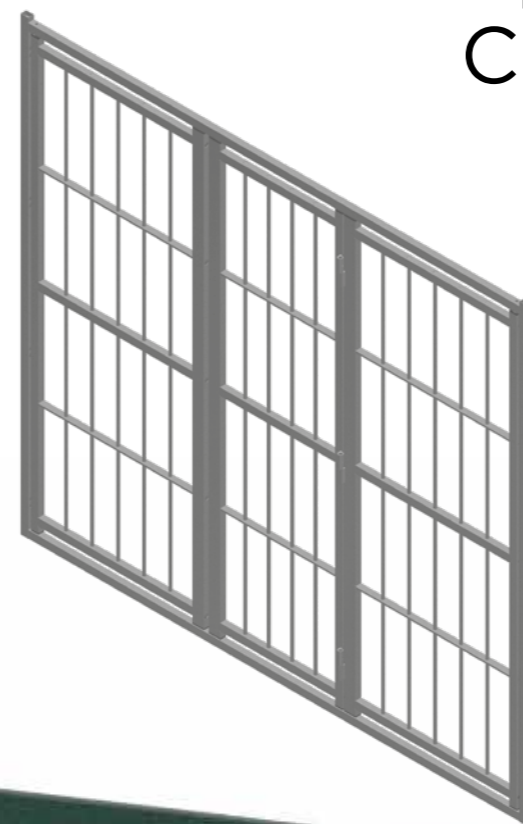



LINEA

FIGHTER

CLASSE 2

FIGHTER CLASSE 2

FIGHTER E' LA NUOVA LINEA DI GRATE ANTIEFFRAZIONE IN CLASSE 2 FIRMATA ALIAS.

A SECONDA DEI MODELLI PUÒ AVERE 2 O 4 TRAVERSI ORIZZONTALI TONDI PIUTTOSTO CHE ESSERE DOTATA DI BORCHIE DECORATIVE. INCONFONDIBILE RESTA IL FILE ROUGE CHE ACCOMUNA TUTTE LE LINEE DI PRODOTTO ALIAS: LINEE PRECISE GRAZIE ANCHE AL TAGLIO LASER CHE GARANTISCE LA TOTALE ASSENZA DI SALDATURE A VISTA.

Fighter est la nouvelle ligne de grilles en classe 2 signée alias. Selon les modèles, la grille peut avoir 2 ou 4 barres horizontales rondes ou équipée de clous décoratifs. Inimitable reste l'idée qui combine toutes les lignes de produits alias: des lignes précises aussi grâce à la coupe au laser qui garantit l'absence totale de soudures inesthétiques.



FIGHTER

CERNIERA A SCOMPARSA CON PERNO

FIGHTER CHARNIÈRES
INTERNES AVEC PIVOT

FIGHTER 100,
LATO ESTERNO

FIGHTER 100
COTE' EXTERNE



FIGHTER 100,
LATO INTERNO

FIGHTER 100
COTE' INTERNE



PARTICOLARE DEL TRAVERSO TONDO
DÉTAIL DE LA BARRE RONDE

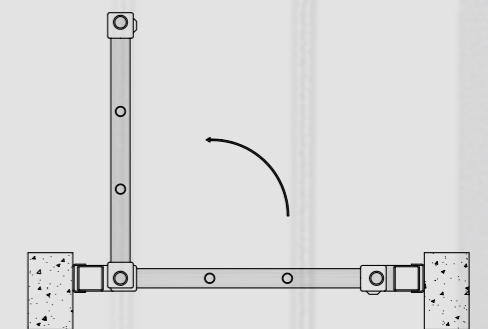

FIGHTER

CERNIERA A VISTA
CON PERNO A SFERA
CHE SOSTITUISCE I DUE
SNODI IN CASO DI
PERSIANA APERTA

FIGHTER CHARNIÈRES EXTERNE
AVEC PIVOT À BILLE QUI REMPLACE
LES DEUX ARTICULATIONS SI LA
PERSIENNE EST OUVERTE

PARTICOLARE DEL TRAVERSO TONDO E DECORO
DÉTAIL DE LA BARRE RONDE AVEC DÉCORATION



FIGHTER 200,
LATO ESTERNO

FIGHTER 200
COTE' ESTERNE

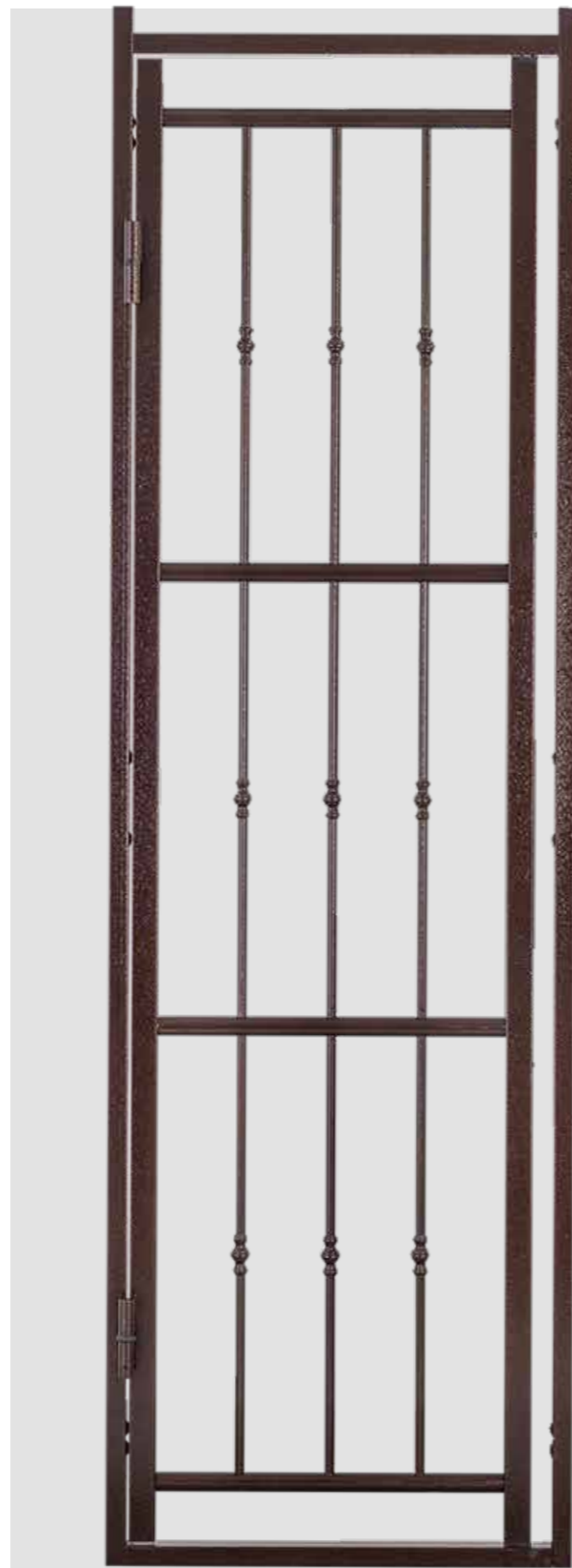

FIGHTER 200,
LATO INTERNO

FIGHTER 200
COTE' INTERNE

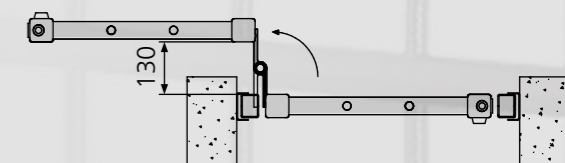

TUTTI I MODELLI FIGHTER APRIBILI POSSONO ESSERE DOTATI DI UN SISTEMA (OPZIONE SU RICHIESTA SENZA SOVRAPPREZZO) CHE SOSTITUISCE I DUE SNODI IN CASO DI PERSIANA APRIBILE.

E' POSSIBILE SCEGLIERE TRA PIÙ DI 30 FINITURE MARTELLATE E METALLIZZATE, OLTRE CHE TRA TUTTE QUELLE PRESENTI NELLA TABELLA RAL.



Tous les modèles Fighter ouvrant peuvent être équipés d'un système (option sur demande sans plus value) qui remplace les deux articulations si la persienne est ouvrante. Il est possible de choisir entre plus de 30 finitions tachetés et métalliques, en plus de toutes celles présentes dans le table RAL.

MODELLI

MODELLI CON 2 O 4
BARRE ORIZZONTALI
PIENE E TONDE CON
O SENZA DECORI

MODÈLES AVEC 2 OU 4 BARRES
HORIZONTALES PLEINES ET RONDES
AVEC OU SANS DÉCORATIONS

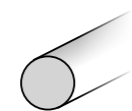

PARTICOLARE DEI TRAVERSI TONDI

DÉTAIL DE LA BARRE RONDE



FIGHTER F200

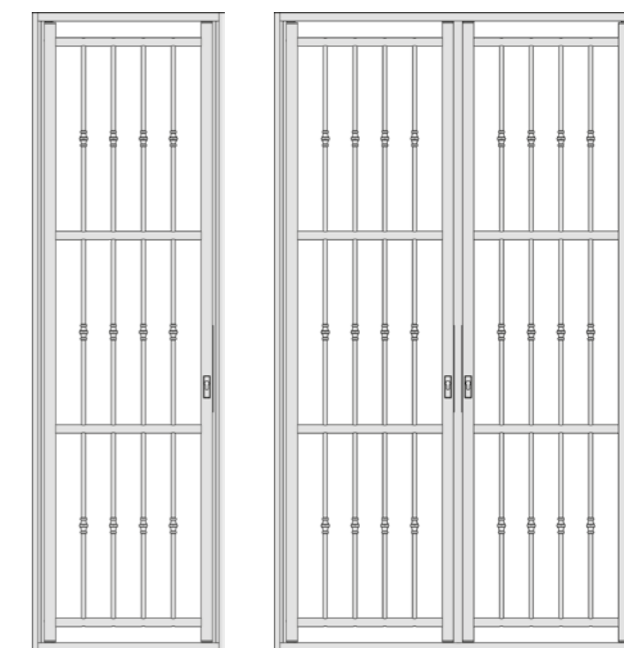
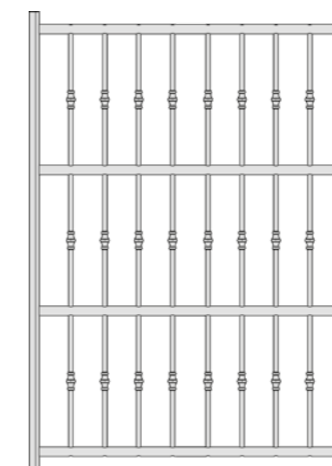
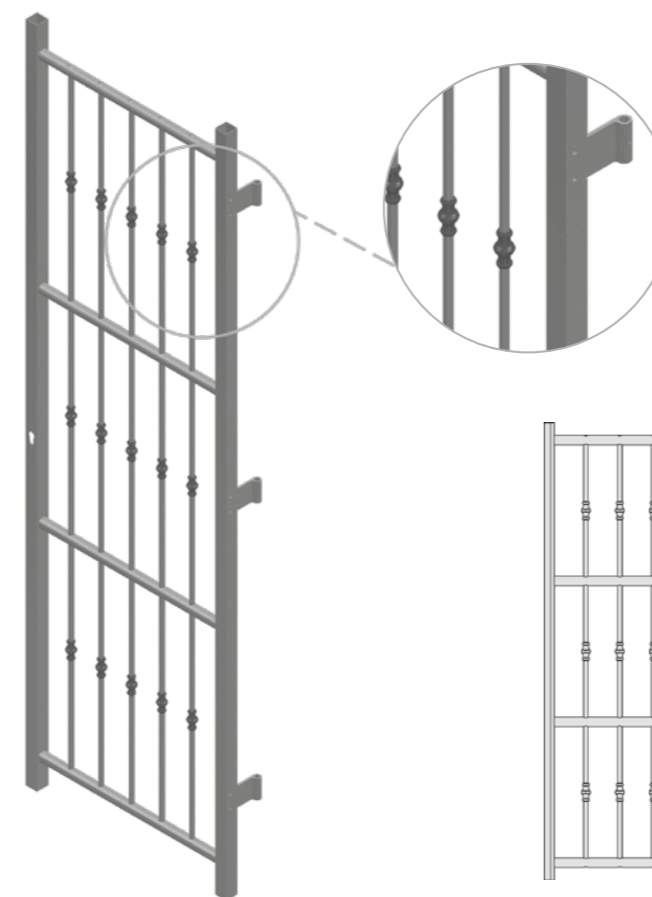

FIGHTER F100

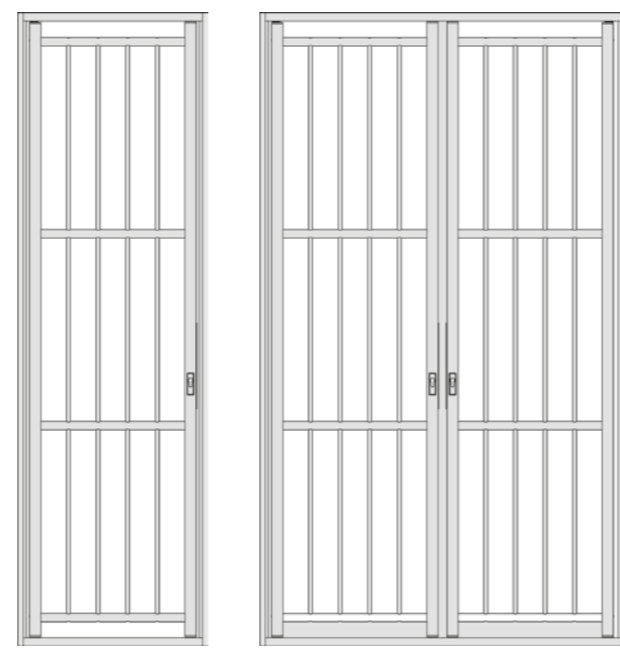
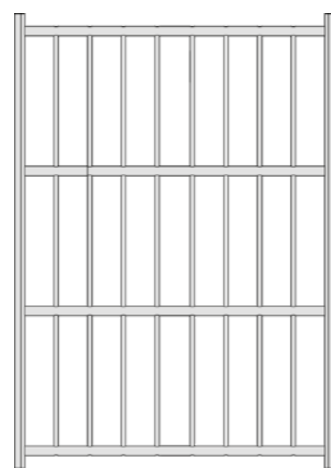
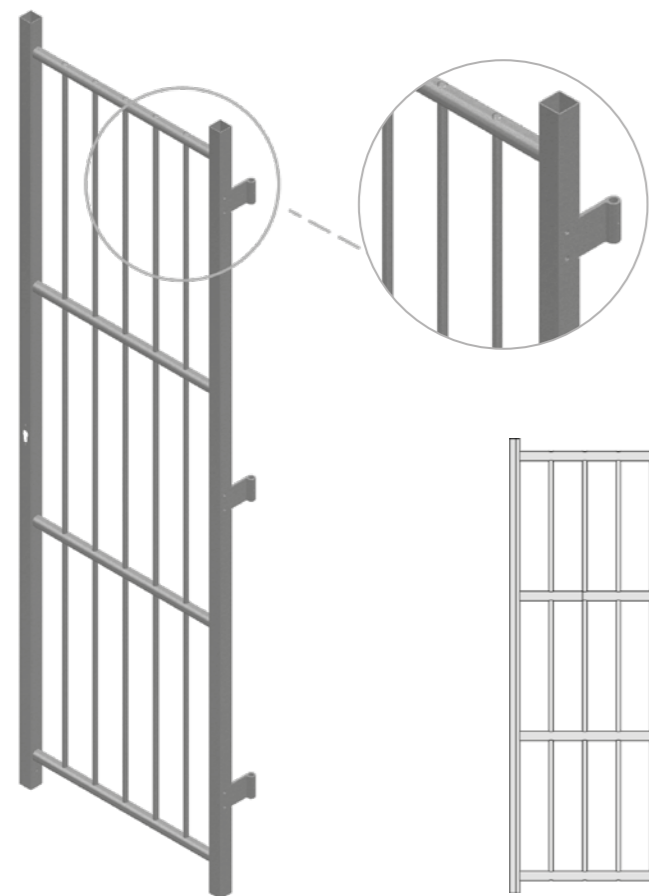

FIGHTER F300

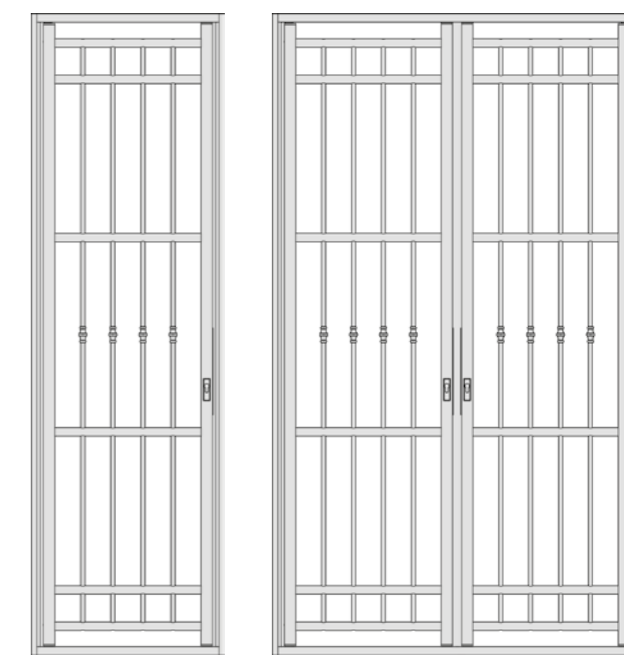
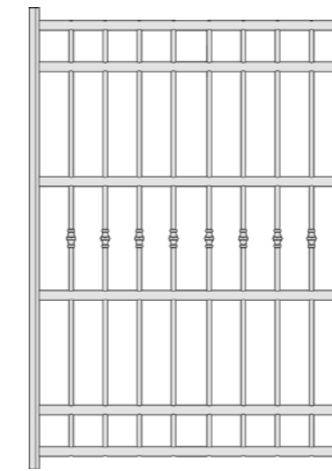
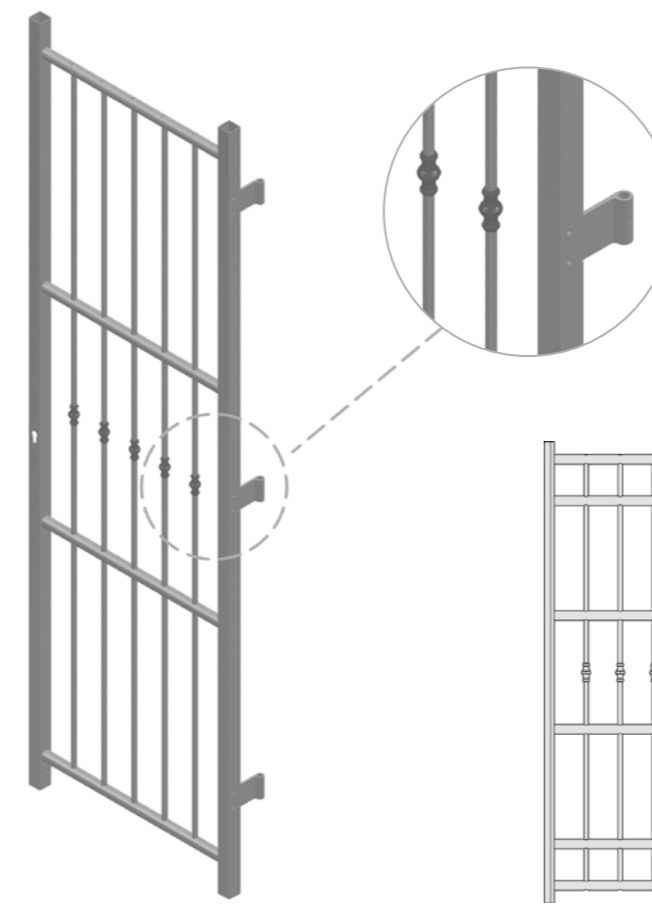

GRATE CON SUPPLEMENTO FISSI SUPERIORI

GRILLES AVEC ELEMENTS
FIXES SUPÉRIEURS

E' POSSIBILE AGGIUNGERE UN ELEMENTO FISSO SUPERIORE AD ARCO, CHE PREVEDA ANCHE I DECORI ABBINATI ALL'INFERRIATA SOTTOSTANTE, IN MODO DA SODDISFARE ANCHE LE ESIGENZE ARCHITETTONICHE PIÙ PARTICOLARI MANTENENDO LA MASSIMA FUNZIONALITÀ E SICUREZZA. E' DISPONIBILE ANCHE IN VERSIONE TRAPEZOIDALE ADATTA A SOTTOSCALA O A SOTTOTETTI INCLINATI.

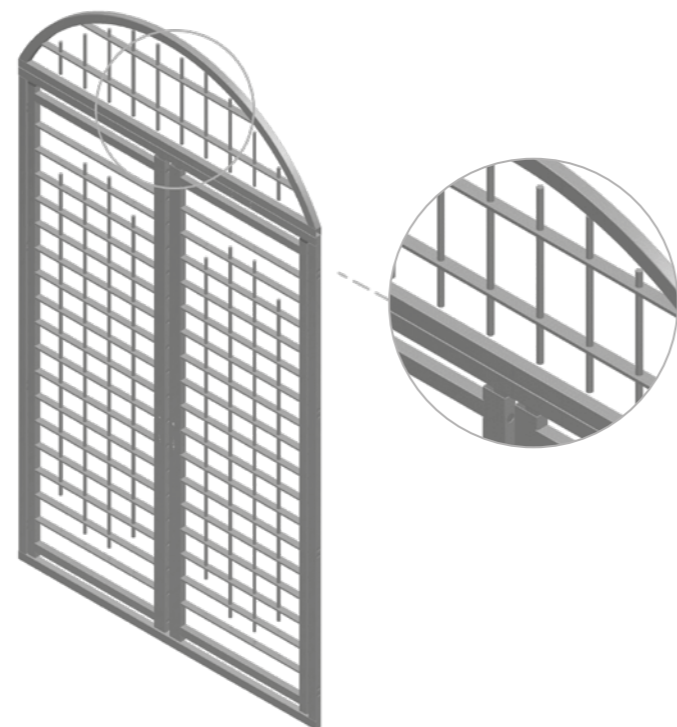

Il est possible d'ajouter un élément fixe supérieur cintré avec les mêmes décorations de la grille installée, afin de satisfaire soit les besoins architecturaux soit une fonctionnalité et une sécurité maximales. Il est également disponible dans une version trapézoïdale adaptée aux sous-escaliers ou aux greniers incliné.

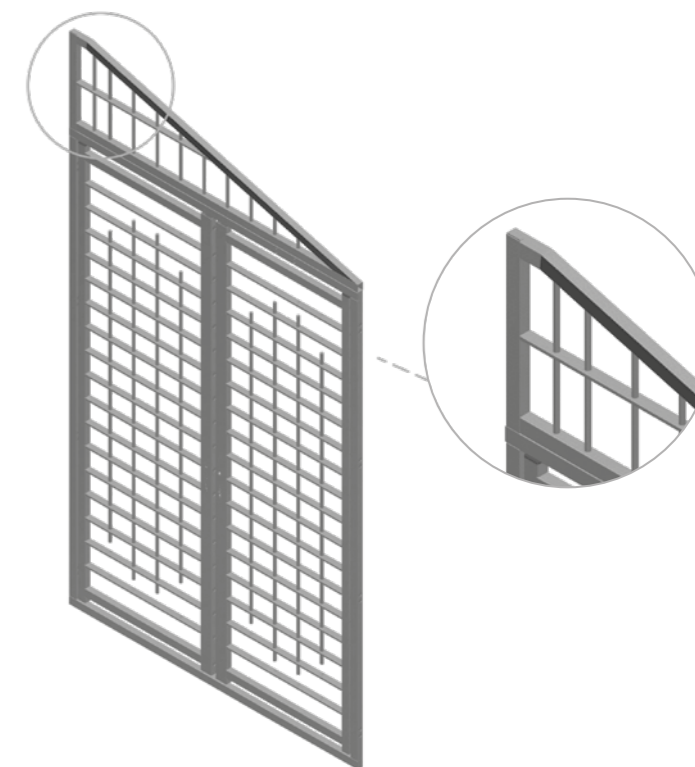

Versione ad arco

VERSION CINTREE

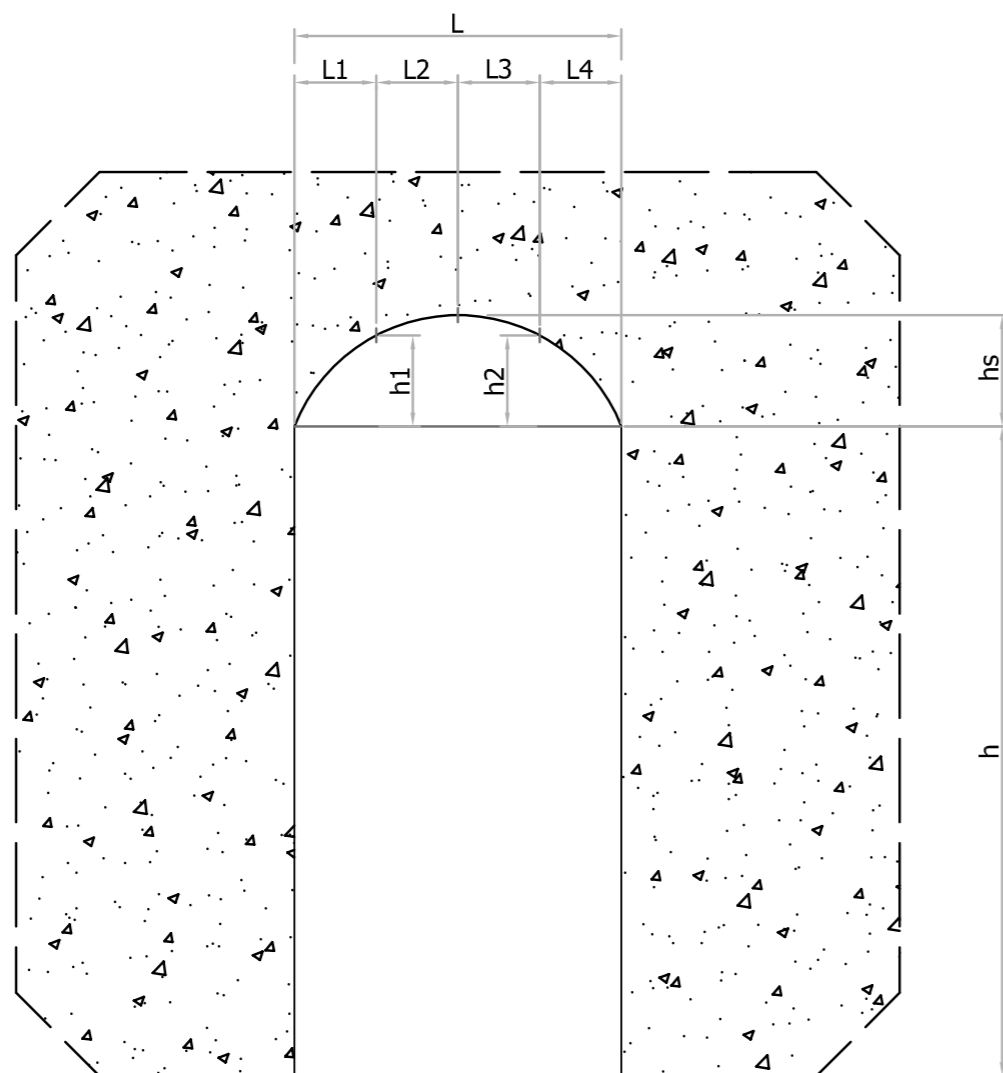
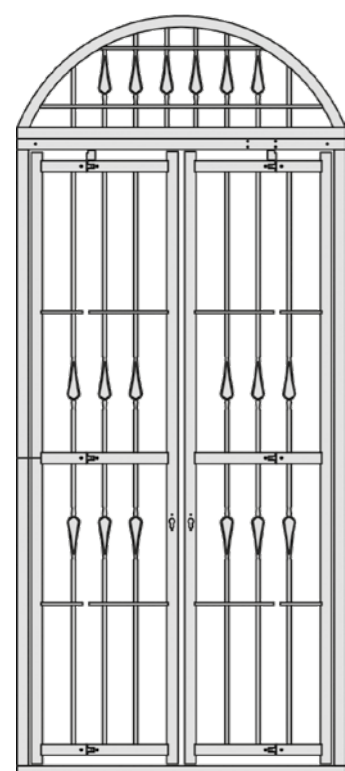

Versione a trapezio

VERSION TRAPEZE

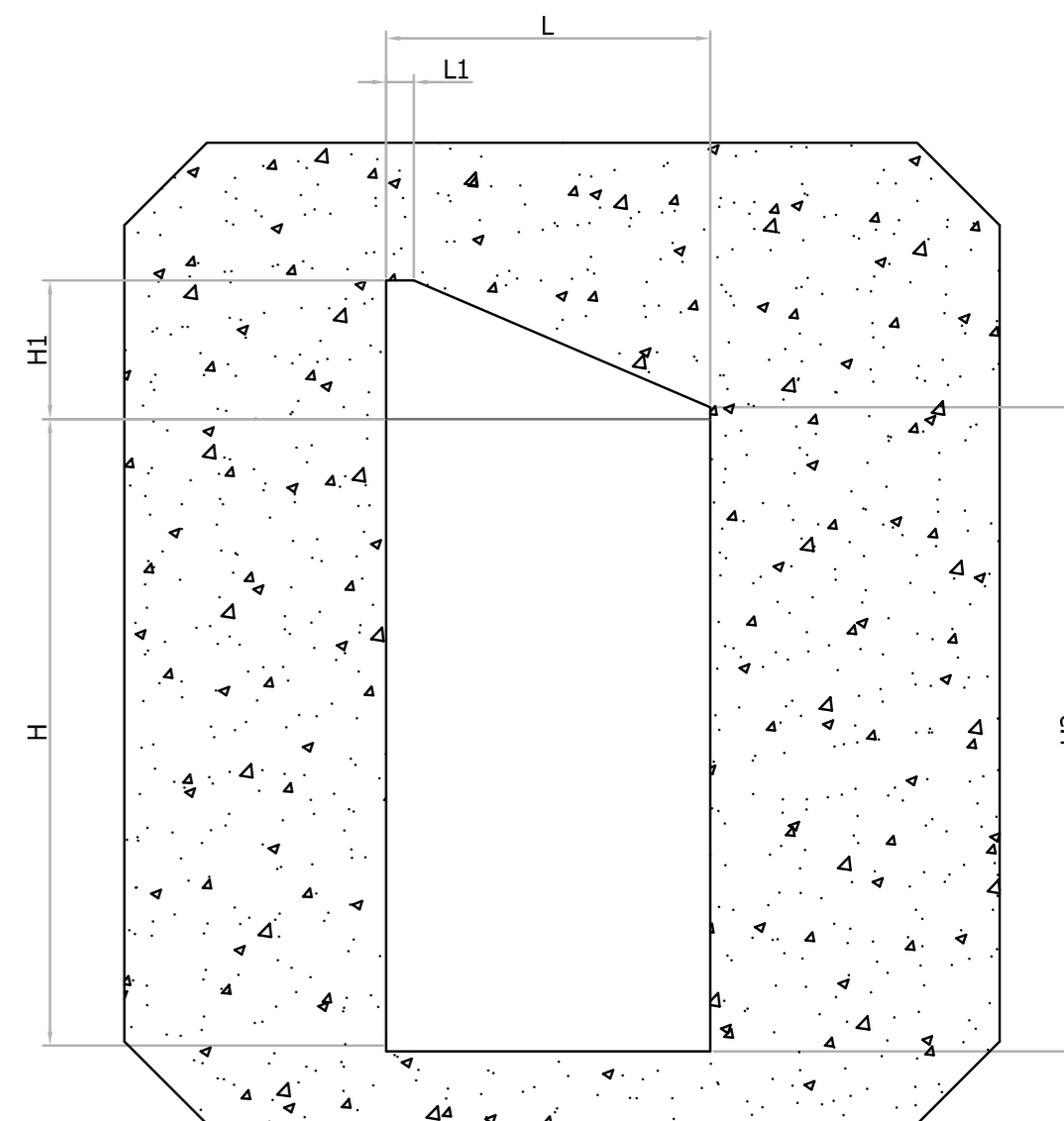
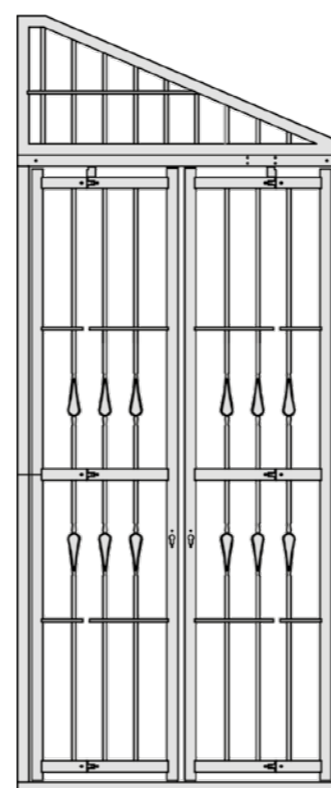

KIT GRATE

IL KIT A Z CON ANGOLARE PROLUNGATO È UN SISTEMA DI FISSAGGIO APPLICABILE A TUTTI I MODELLI DI GRATE ED È ADATTO AD UN'APPLICAZIONE IN AMBITO DI RISTRUTTURAZIONE QUALORA SI VOGLIA COLLOCARE LA GRATA A RIDOSSO DEL FILO MURO ESTERNO. IL PROFILO IN ACCIAIO VERNICIATO PER IL FISSAGGIO È REALIZZABILE ANCHE CON MISURA A RICHIESTA.

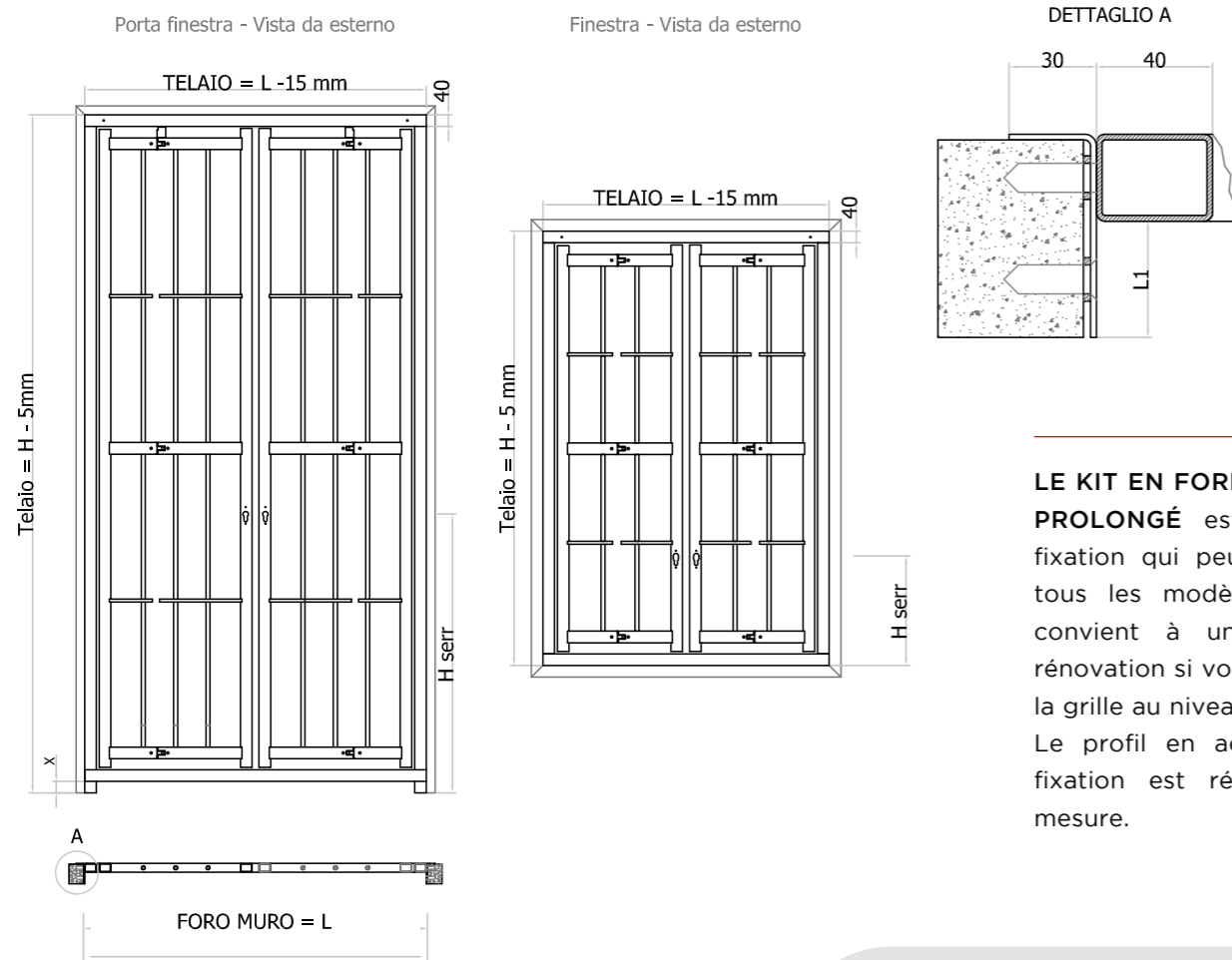

LE KIT EN FORME DE Z À ANGLE PROLONGÉ est un système de fixation qui peut être appliqué à tous les modèles des grilles et convient à une application en rénovation si vous souhaitez placer la grille au niveau du mur extérieur. Le profil en acier verni pour la fixation est réalisable aussi sur mesure.

IL KIT A Z CON PIASTRE DI FISSAGGIO È APPLICABILE A TUTTI I MODELLI DI GRATE E PENSATO PER CHI HA L'ESIGENZA DI UN FISSAGGIO FRONTALE SUL MURO.

LE KIT EN FORME DE Z AVEC PLAQUES DE FIXATION est applicable à tous les modèles de grilles et conçu pour qui a besoin d'une fixation frontale au mur.

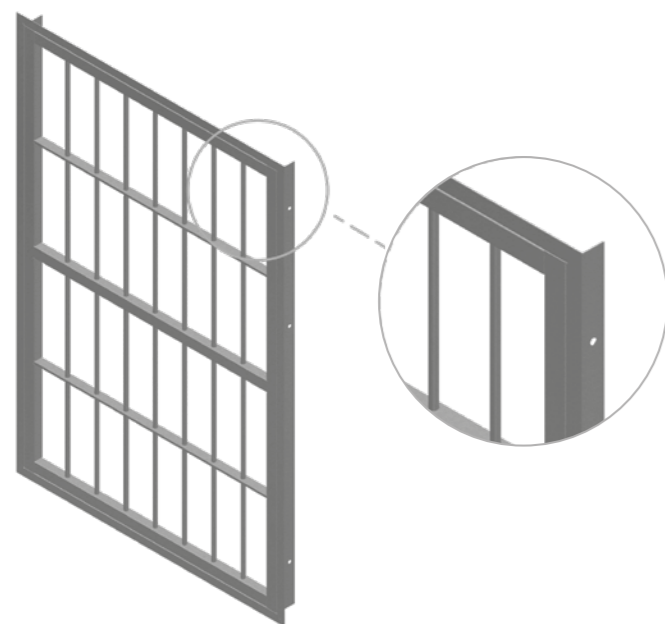
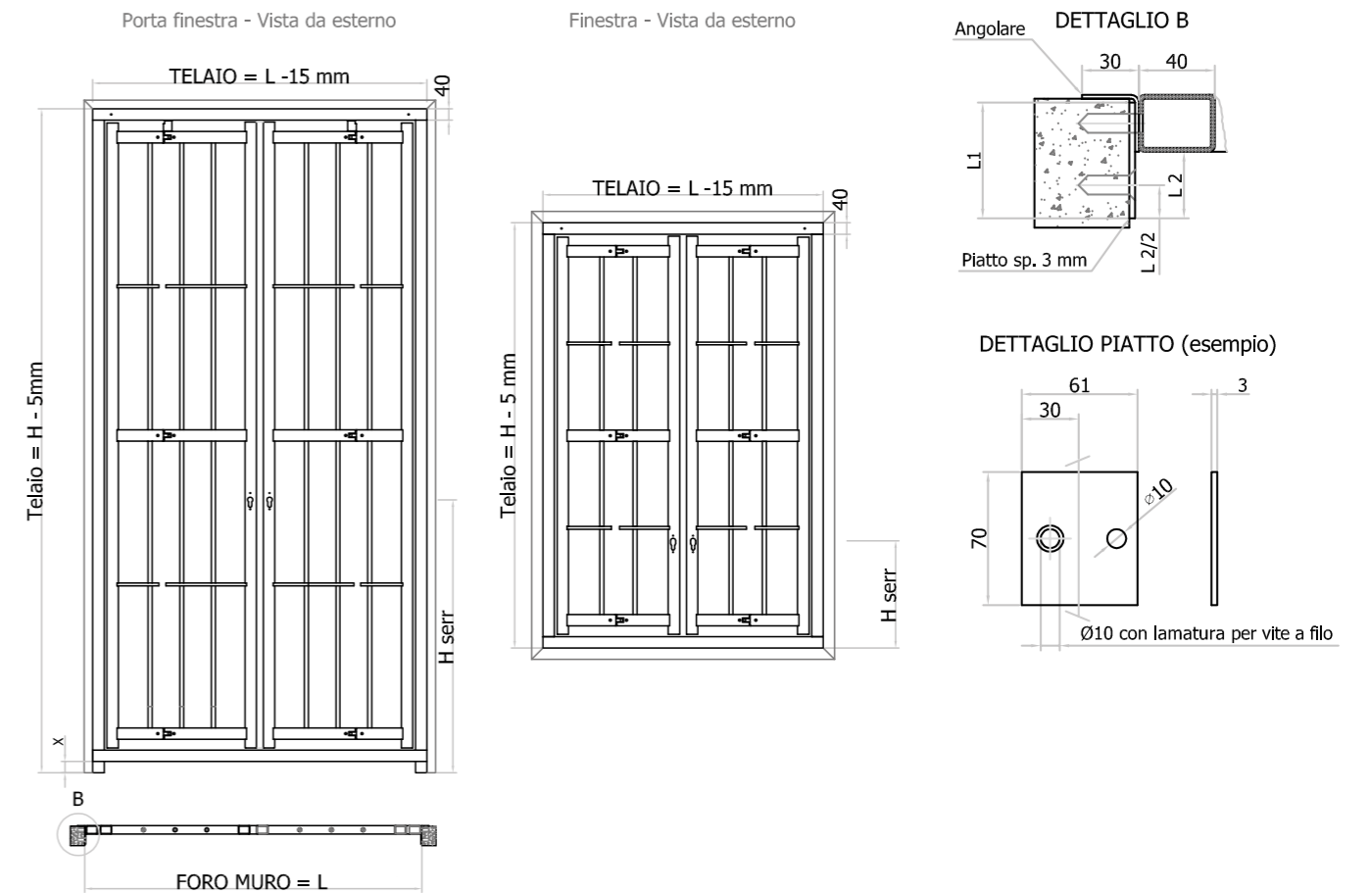

KIT A INGOMBRO RIDOTTO SOLO TELAIO

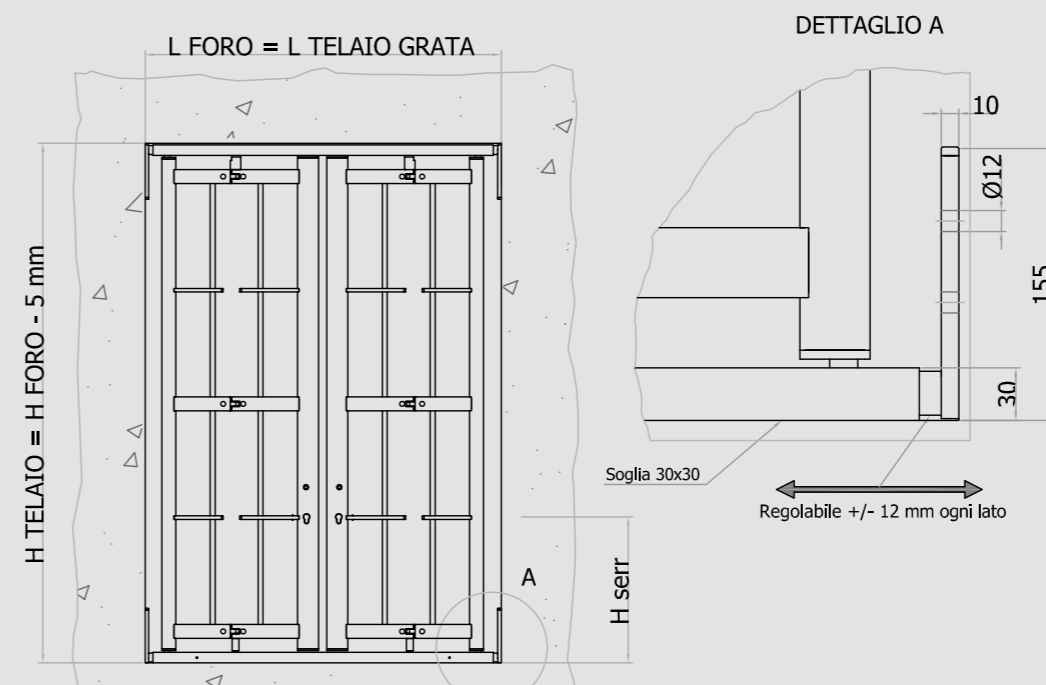

IL KIT A INGOMBRO RIDOTTO È APPLICABILE SOLO AI MODELLI DELLA SERIE DEFENDER E PERMETTE DI AUMENTARE LA LUCE PASSAGGIO DA CINQUE A OTTO CENTIMETRI CIRCA, ELIMINANDO I MONTANTI LATERALI E ACQUISENDO UNA MAGGIORE PULIZIA ESTETICA.

LE KIT DE MESURE RÉDUITE est applicable uniquement aux modèles de la série Defender et vous permet d'augmenter le passage d'environ cinq à huit centimètres en éliminant les montants latéraux, acquérant un plus grand effet esthétique.

SCHEDA RILIEVO - MISURE GRATE

Fiche technique

APPLICAZIONE CON SORMONTI VERTICALI E TUBOLARI LATERALI AGGIUNTIVI STRUCTURE AVEC DES MONTANTS VERTICAUX ET COMPENSATEURS LATÉRAUX AJOUTÉS

Vista da interno / Vue intérieure

Telaio / Cadre = L - 15 mm

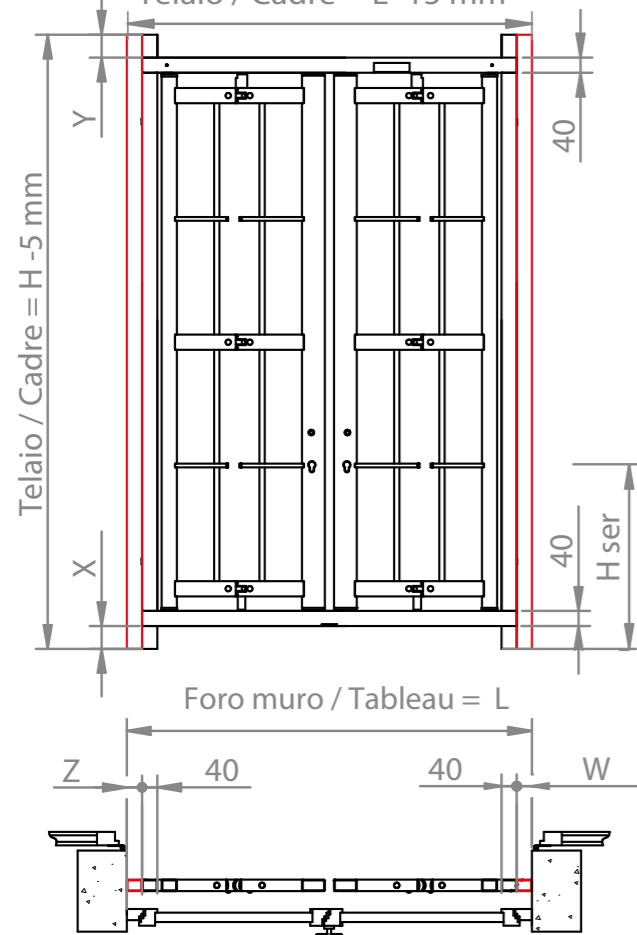

APPLICAZIONE STANDARD APPLICATION STANDARD

Vista da interno / Vue intérieure

Telaio / Cadre = L - 15 mm

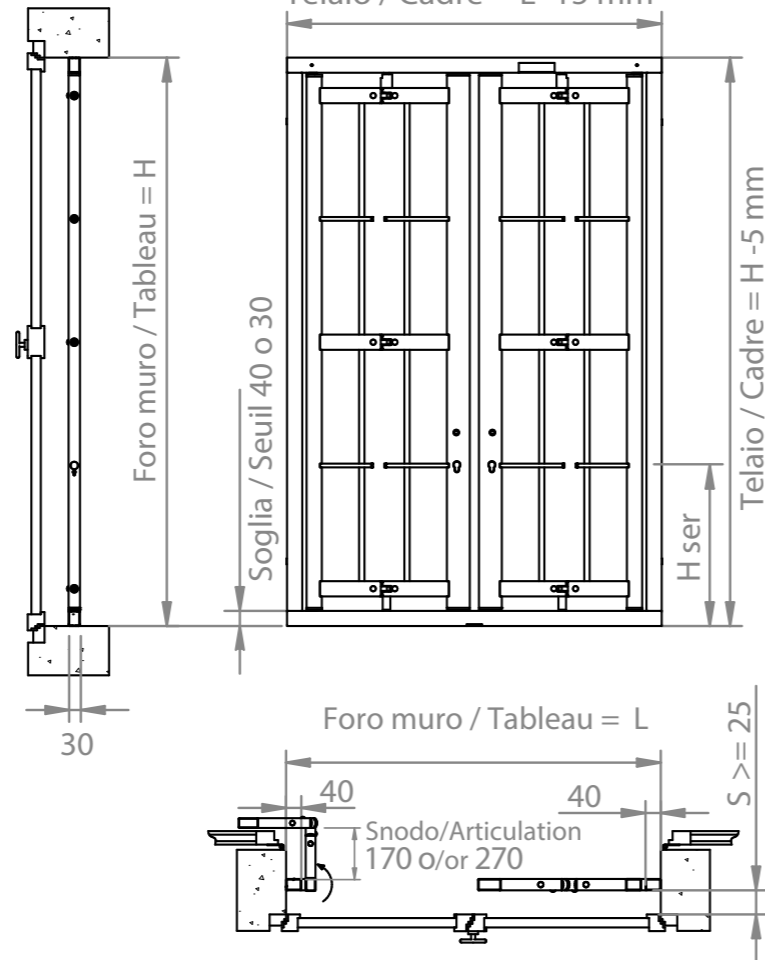

N.B.: Per soluzioni particolari differenti da quelle standard, contattare il nostro ufficio tecnico.

Pour des indications différentes du standard, veuillez contacter nos services techniques.

LEGENDA / LEGEND:

L: Luce orizzontale muro / Côte tableau (horizontale)

H: Luce verticale muro / Côte tableau (Verticale)

X: Sormonto telaio inferiore / Côte barre supérieure (Barre/mur)

Y: Sormonto telaio superiore / Côte barre inférieure (Barre/sol)

Z: Tubolare aggiuntivo SX, misure 20 30 40 50 60 100 / Compensateur SX, Côtes 20 30 40 50 60 100

W: Tubolare aggiuntivo DX, misure 20 30 40 50 60 100 / Compensateur DX, Côtes 20 30 40 50 60 100

SENSI DI APERTURA DIRECTIVES D'OUVERTURE

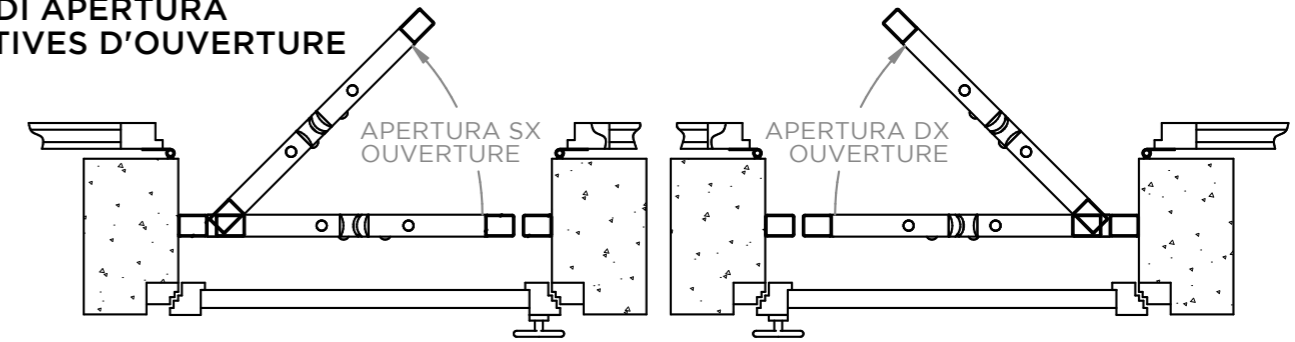

1 ANTA 2 SNODI 1 VANTAIL 2 ARTICULATIONS

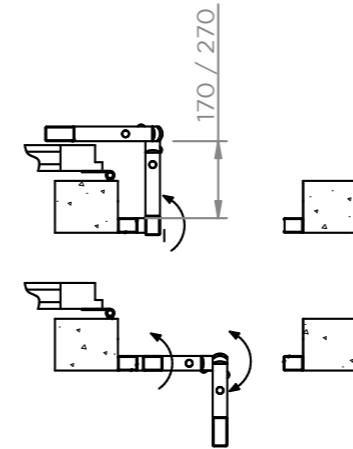

1 ANTA 1 SNODO 1 VANTAIL 1 ARTICULATION

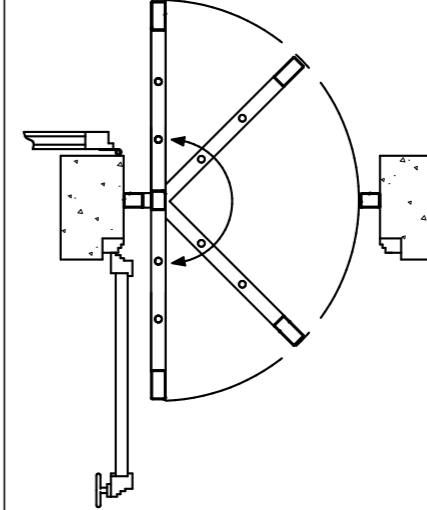

ANTA FISSA VANTAIL FIX

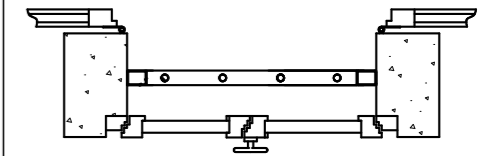

2 ANTE 2 SNODI 2 VANTAIL 2 ARTICULATIONS

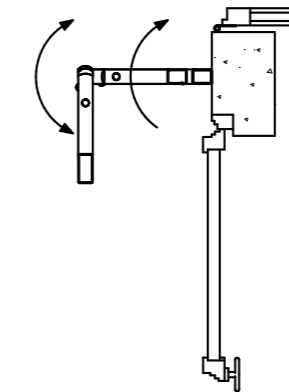
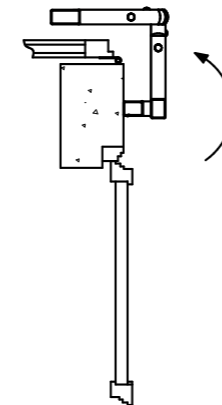

2 ANTE 1 SNODO 2 VANTAIL 1 ARTICULATIONS

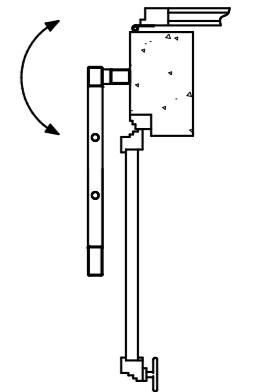
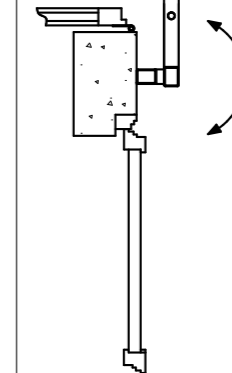

COLORI E FINITURE DISPONIBILI

Couleurs et finitions disponibles

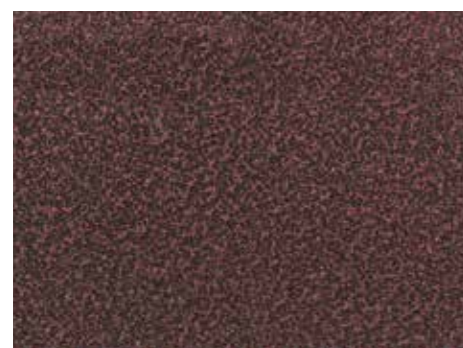

**RAME MARTELLATO
CUIVRE MARTELÉ**



**MARRONE TESTA DI MORO GRINZ
MARRON FONCÉ GRINZ**



**RUGGINE
ROUILLE**



**BIANCO GLITTER
BLANC GLITTER**



**GRIGIO GLITTER
GRIS GLITTER**



**VERDE RAFFAELLO
VERT RAFFAELLO**



**GRIGIO SABBIA
GRIS SABLE**



**MARRONE GLITTER
MARRON GLITTER**



**VERDE GLITTER
VERT GLITTER**



**VERDE RAL 6005 GRINZ
VERT RAL 6005 GRINZ**

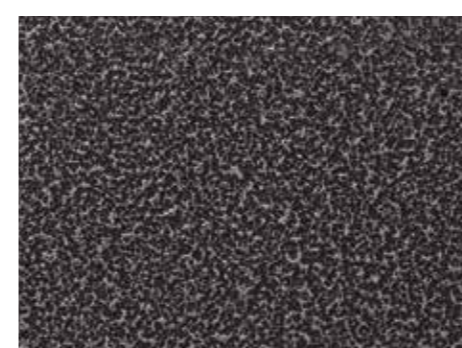

**NERO MARTELLATO
NOIR MARTELÉ**



COLORI RAL

Couleurs RAL



MAZZETTA
CAMPIONI COLORI
ED EFFETTI
SPECIALI
ALIAS

Groupe échantillons
de couleur et
effets spécial
Alias





Le riproduzioni dei colori sul catalogo cartaceo possono risentire di tutte le variazioni di tono e di colore imputabili ai processi di stampa. Queste immagini servono dunque esclusivamente per orientare la prima scelta del Cliente

All reproductions of colours on the paper catalogue can be subject to tone and shade variations that can be attributed to the print process. These images are inserted with the only purpose to guide customers in their first choice



ALIAS

Alias srl

Via Berlinguer, 22 - Settima 29020 (PC) - Italy

Tel: +39 0523 364040 Fax: +39 0523 364044

Email: info@aliasblindate.com

Web e Privacy: aliasblindate.com